

TO: A/Administrator 8 July 1969  
FROM: MA/Apollo Program Director  
SUBJECT: Apollo 11 Mission (AS-506)

No earlier than 16 July 1969, we plan to launch Apollo 11 on the first lunar landing mission. This will be the fourth manned Saturn V flight, the fifth flight of a manned Apollo Command/Service Module, and the third flight of a manned Lunar Module.

Apollo 11 will be launched from Pad A of Launch Complex 39 at the Kennedy Space Center. Lunar touchdown is planned for Apollo Landing Site 2, located in the southwest corner of the Sea of Tranquility. The planned lunar surface activities will include collection of a Contingency Sample, assessment of astronaut capabilities and limitations, collection of Bulk Samples, deployment of experiment packages including a laser reflector and instruments for measuring seismic activity, and collection of a Documented Lunar Soil Sample. Photographic records will be obtained and extravehicular activity will be televised. The 8-day mission will be completed with landing in the Pacific Ocean. Recovery and transport of the crew, spacecraft, and lunar samples to the Lunar Receiving Laboratory at the Manned Spacecraft Center will be conducted under quarantine procedures that provide for biological isolation.

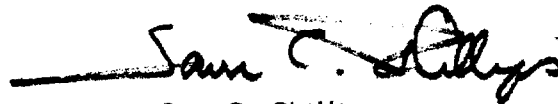

Sam C. Phillips  
Lt. General, USAF  
Apollo Program Director

APPROVAL:



George E. Mueller  
Associate Administrator for  
Manned Space Flight

# MISSION OPERATION REPORT

# APOLLO 11 (AS-506) MISSION

OFFICE OF MANNED SPACE FLIGHT  
Prepared by: Apollo Program Office - MAO



HERE MEN FROM THE PLANET EARTH  
FIRST SET FOOT UPON THE MOON  
JULY 1969, A. D.

WE CAME IN PEACE FOR ALL MANKIND

NEIL A. ARMSTRONG  
ASTRONAUT

MICHAEL COLLINS  
ASTRONAUT

EDWIN E. ALDRIN, JR.  
ASTRONAUT

RICHARD NIXON  
PRESIDENT, UNITED STATES OF AMERICA



FOR INTERNAL USE ONLY

## FOREWORD

MISSION OPERATION REPORTS are published expressly for the use of NASA Senior Management, as required by the Administrator in NASA Instruction 6-2-10, dated 15 August 1963. The purpose of these reports is to provide NASA Senior Management with timely, complete, and definitive information on flight mission plans, and to establish official mission objectives which provide the basis for assessment of mission accomplishment.

Initial reports are prepared and issued for each flight project just prior to launch. Following launch, updating reports for each mission are issued to keep General Management currently informed of definitive mission results as provided in NASA Instruction 6-2-10.

Because of their sometimes highly technical orientation, distribution of these reports is provided to personnel having program-project management responsibilities. The Office of Public Affairs publishes a comprehensive series of prelaunch and postlaunch reports on NASA flight missions, which are available for general distribution.

APOLLO MISSION OPERATION REPORTS are published in two volumes: the MISSION OPERATION REPORT (MOR); and the MISSION OPERATION REPORT, APOLLO SUPPLEMENT. This format was designed to provide a mission-oriented document in the MOR, with supporting equipment and facility description in the MOR, APOLLO SUPPLEMENT. The MOR, APOLLO SUPPLEMENT is a program-oriented reference document with a broad technical description of the space vehicle and associated equipment; the launch complex; and mission control and support facilities.

Published and Distributed by  
PROGRAM and SPECIAL REPORTS DIVISION (XP)  
EXECUTIVE SECRETARIAT - NASA HEADQUARTERS

CONTENTS

	<u>Page</u>
Apollo 11 Mission . . . . .	1
Program Development . . . . .	5
NASA OMSF Primary Mission Objectives for Apollo 11 . . . . .	7
Detailed Objectives and Experiments . . . . .	8
Launch Countdown and Turnaround Capability, AS-506 . . . . .	9
Detailed Flight Mission Description . . . . .	16
Back Contamination Program . . . . .	50
Contingency Operations . . . . .	56
Configuration Differences . . . . .	69
Mission Support . . . . .	71
Recovery Support Plan . . . . .	76
Flight Crew . . . . .	90
Mission Management Responsibility . . . . .	100
Program Management . . . . .	101
Abbreviations and Acronyms . . . . .	102

LIST OF FIGURES

<u>Figure</u>	<u>Title</u>	<u>Page</u>
1	Apollo 11 Flight Profile	2
2	Summary Timeline, Nominal Lunar Surface EVA	3
3	Launch Countdown (AS-506)	10
4	Turnaround From Scrub, AS-506	11
5	Scrub/Turnaround Possibilities, AS-506 July Launch Window	14
6	Second Scrub/Turnaround Matrix	15
7	Mission Durations, July Launch Windows	17
8	Apollo Lunar Landing Sites	19
9	Ascent Trajectory	22
10	Earth Orbital Configuration	22
11	Transposition, Docking, Ejection	22
12	Translunar Configuration	22
13	Lunar Orbit Insertion	24
14	Descent Orbit Insertion	25
15	Lunar Module Descent	25
16	Landing Radar - Antenna Beam Configuration	26
17	Landing Approach Phase	27
18	Lunar Contact Sequence	27
19	Lunar Surface Activity Timeline For 22-Hour Stay	29
20	Lunar Surface Activity	30
21	Removal of Stowed Tools From MESA	32
22	Preparation of Hand Tool	33
23	Deployed Solar Wind Composition Experiment	34
24	Early Apollo Scientific Experiments Package Deployment	37
25	Deployed Passive Seismic Experiment	38
26	Deployed Laser Ranging Retro-Reflector	39
27	Documented Sample Collection	40
28	Lunar Module Vertical Rise Phase	44
29	Orbit Insertion Phase	44
30	Rendezvous Maneuvers/ Radar Coverage	45
31	Lunar Activities Summary	46
32	Transearth Configuration	47
33	Transearth Phase	48
34	Entry & Descent to Earth	48
35	Apollo Back Contamination Program	51
36	Apollo 11 Nominal Mission Events and Contingency Options	57-59
37	Recovery Lines	62
38	Apollo Earth Orbit Chart (AEO)	72

6/24/69

39	Apollo Lunar Surface Communications	74
40	Radar Coverage During Lunar Orbit Periods for Launch Date of July 16	75
41	Apollo 11 Launch Site Area and Force Deployment	77
42	Launch Abort Area and Force Deployment	79
43	Apollo 11 Earth Parking Orbit Recovery Zones	82
44	Deep Space Typical Secondary Landing Area and Force Deployment	84
45	Typical Primary Landing Area and Force Deployment	88
46	Apollo 11 Prime Crew	91
47	Apollo 11 Back-Up Crew	92

LIST OF TABLES

<u>Table</u>	<u>Title</u>	<u>Page</u>
1	Mission Summary	4
2	Monthly Launch Windows	16
3	Apollo 11 Weight Summary	21
4	Loose Equipment Left on Lunar Surface	42
5	MSFN Mobile Facilities	71
6	MSFN Configuration, Apollo 11 Mission	73
7	Recovery Force Requirements	80
8	Recovery Force Requirements	83
9	Recovery Ship Locations, Deep Space Phase	85
10	HC-130 Minimum Alert Posture	86
11	Recovery Force Requirements	87

## APOLLO 11 MISSION

The primary purpose of the Apollo 11 Mission is to perform a manned lunar landing and return. During the lunar stay, limited selenological inspection, photography, survey, evaluation, and sampling of the lunar soil will be performed. Data will be obtained to assess the capability and limitations of an astronaut and his equipment in the lunar environment. Figure 1 is a summary of the flight profile.

Apollo 11 will be launched from Pad A of Launch Complex 39 at Kennedy Space Center on 16 July 1969. The Saturn V Launch Vehicle and the Apollo Spacecraft will be the operational configurations. The Command Module (CM) equipment will include a color television camera with zoom lens, a 16mm Maurer camera with 5, 18, and 75mm lenses, and a Hasselblad camera with 80 and 250mm lenses. Lunar Module (LM) equipment will include a lunar television camera with wide angle and lunar day lenses, a 16mm Maurer camera with a 10mm lens, a Hasselblad camera with 80mm lens, a Lunar Surface Hasselblad camera with 60mm lens, and a close-up stereo camera. The nominal duration of the flight mission will be approximately 8 days 3 hours. Translunar flight time will be approximately 73 hours. Lunar touchdown is planned for Landing Site 2, located in the southwest corner of the moon's Sea of Tranquility. The LM crew will remain on the lunar surface for approximately 21.5 hours. During this period, the crew will accomplish postlanding and pre-ascent procedures and extravehicular activity (EVA).

The nominal EVA plan, as shown in Figure 2, will provide for an exploration period of open-ended duration up to 2 hours 40 minutes with maximum radius of operation limited to 300 feet. The planned lunar surface activities will include in the following order of priority: (1) photography through the LM window, (2) collection of a Contingency Sample, (3) assessment of astronaut capabilities and limitations, (4) LM inspection, (5) Bulk Sample collection, (6) experiment deployment, and (7) lunar field geology — including collection of a Documented Lunar Soil Sample. Priorities for activities associated with Documented Sample collection will be: (a) core sample, (b) bag samples with photography, (c) environmental sample, and (d) gas sample. Photographic records will be obtained and EVA will be televised. Assessment of astronaut capabilities and limitations during EVA will include quantitative measurements. There will be two rest and several eat periods. The total lunar stay time will be approximately 59.5 hours.

The transearth flight time will be approximately 60 hours. Earth landing will be in the Mid-Pacific recovery area with a target landing point located at 172°W longitude and 11°N latitude. Table 1 is a summary of mission events.

Following landing, the flotation collar will be attached to the CM, the CM hatch will be opened and the crew will don Biological Isolation Garments passed in to them by the recovery swimmer. The crew will then egress the CM, transfer to the recovery ship by helicopter, and will immediately enter the Mobile Quarantine Facility (MQF). They will be transported in the MQF to the Lunar Receiving Laboratory (LRL) at the Manned Spacecraft Center. The CM, Sample Return Containers, film, tapes, and astronaut logs will also be transported to the LRL under quarantine procedures.



6/24/69

# APOLLO 11 FLIGHT PROFILE

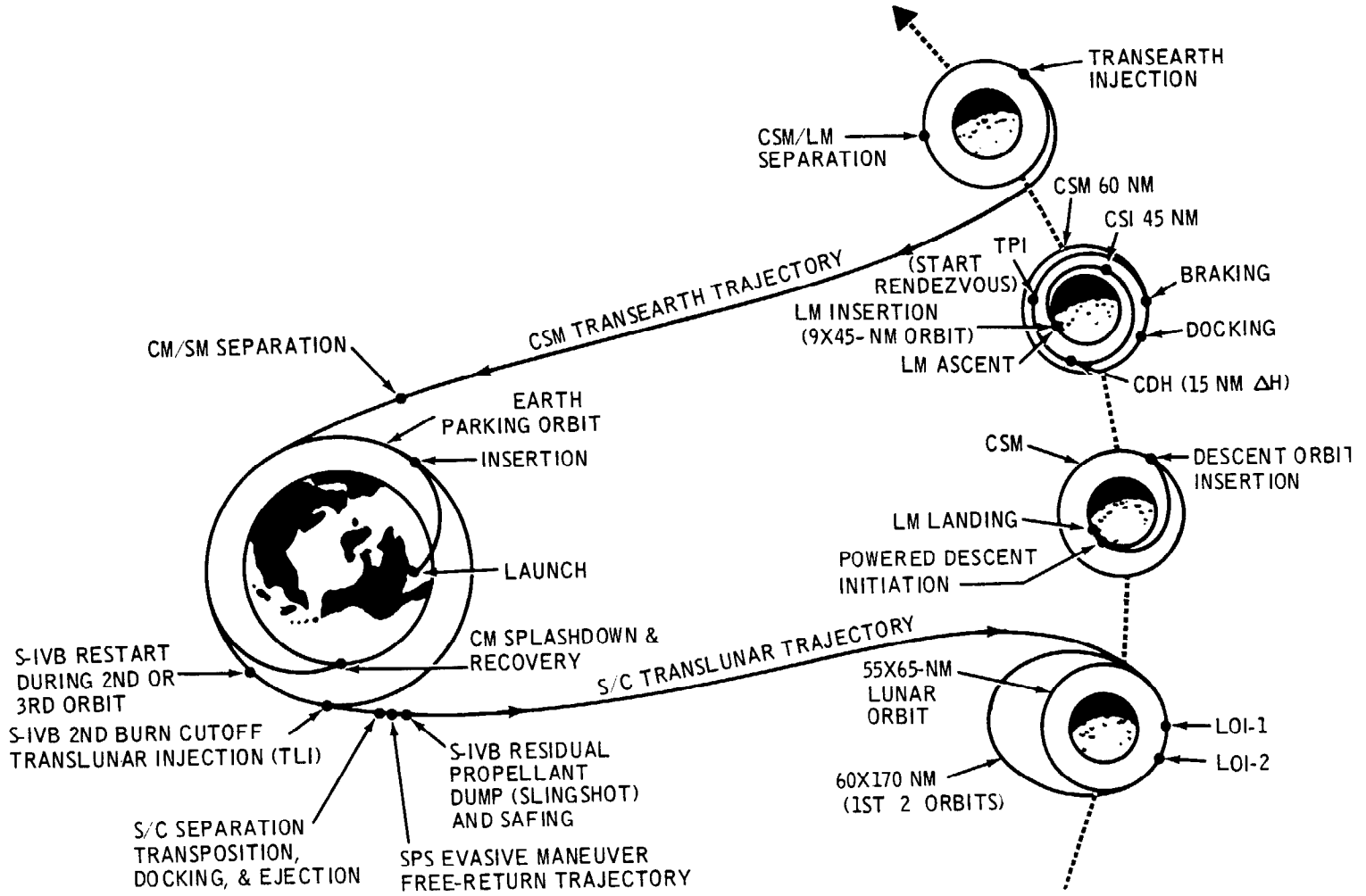

Page 2

Fig. 1

M-932-69-11

TABLE 1

MISSION SUMMARY16 JULY, 72° LAUNCH AZIMUTH,  
FIRST TRANSLUNAR INJECTION OPPORTUNITY

	<u>DURATION</u> (HR:MIN)	<u>GET</u> (DAYS:HR:MIN)	<u>EDT</u> (DAY:HR:MIN)
LAUNCH		0:00:00	16:09:32
EARTH ORBIT COAST	2:32		
TRANSLUNAR INJECTION		0:02:44	16:12:16
TRANSLUNAR COAST	73:10		
LUNAR ORBIT INSERTION-1		3:03:54	19:13:26
LUNAR ORBIT INSERTION-2		3:08:09	19:17:41
DESCENT ORBIT INSERTION		4:05:39	20:15:11
LUNAR LANDING		4:06:47	20:16:19
LUNAR STAY	21:36		
EXTRAVEHICULAR ACTIVITY INITIATION		4:16:39	21:20:11
LUNAR EXTRAVEHICULAR ACTIVITY	2:40		
ASCENT		5:04:23	
DOCKING		5:08:00	21:17:32
LM JETTISON		5:11:53	21:21:25
TOTAL LUNAR ORBIT	59:30		
TRANSEARTH INJECTION		5:15:25	22:00:57
TRANSEARTH COAST	59:38		
EARTH LANDING		8:03:17	24:12:49

## PROGRAM DEVELOPMENT

The first Saturn vehicle was successfully flown on 27 October 1961, initiating operations in the Saturn I Program. A total of 10 Saturn I vehicles (SA-1 to SA-10) was successfully flight tested to provide information on the integration of launch vehicle and spacecraft and to provide operational experience with large multiengined booster stages (S-I, S-IV).

The next generation of vehicles, developed under the Saturn IB Program, featured an updated first stage (S-IB) and a more powerful new second stage (S-IVB). The first Saturn IB was launched on 26 February 1966. The first three Saturn IB missions (AS-201, AS-203, and AS-202) successfully tested the performance of the launch vehicle and spacecraft combination, separation of the stages, behavior of liquid hydrogen in a weightless environment, performance of the Command Module heat shield at low earth orbital entry conditions, and recovery operations.

The planned fourth Saturn IB mission (AS-204) scheduled for early 1967 was intended to be the first manned Apollo flight. This mission was not flown because of a spacecraft fire, during a manned prelaunch test, that took the lives of the prime flight crew and severely damaged the spacecraft. The SA-204 Launch Vehicle was later assigned to the Apollo 5 Mission.

The Apollo 4 Mission was successfully executed on 9 November 1967. This mission initiated the use of the Saturn V Launch Vehicle (SA-501) and required an orbital restart of the S-IVB third stage. The spacecraft for this mission consisted of an unmanned Command/Service Module (CSM) and a Lunar Module test article (LTA). The CSM Service Propulsion System (SPS) was exercised, including restart, and the Command Module Block II heat shield was subjected to the combination of high heat load, high heat rate, and aerodynamic loads representative of lunar return entry. All primary mission objectives were successfully accomplished.

The Apollo 5 Mission was successfully launched and completed on 22 January 1968. This was the fourth mission utilizing Saturn IB vehicles (SA-204). This flight provided for unmanned orbital testing of the Lunar Module (LM-1). The LM structure, staging, and proper operation of the Lunar Module Ascent Propulsion System (APS) and Descent Propulsion System (DPS), including restart, were verified. Satisfactory performance of the S-IVB/Instrument Unit (IU) in orbit was also demonstrated. All primary objectives were achieved.

The Apollo 6 Mission (second unmanned Saturn V) was successfully launched on 4 April 1968. Some flight anomalies were encountered, including oscillations reflecting propulsion-structural longitudinal coupling, an imperfection in the Spacecraft-LM Adapter (SLA) structural integrity, and malfunctions of the J-2 engines in the S-II and S-IVB stages. The spacecraft flew the planned trajectory, but preplanned high velocity reentry conditions were not achieved. A majority of the mission objectives for Apollo 6 was accomplished.

The Apollo 7 Mission (first manned Apollo) was successfully launched on 11 October 1968. This was the fifth and last planned Apollo mission utilizing a Saturn IB Launch Vehicle (SA-205). The 11-day mission provided the first orbital tests of the Block II Command/Service Module. All primary mission objectives were successfully accomplished. In addition, all planned detailed test objectives, plus three that were not originally scheduled, were satisfactorily accomplished.

The Apollo 8 Mission was successfully launched on 21 December and completed on 27 December 1968. This was the first manned flight of the Saturn V Launch Vehicle and the first manned flight to the vicinity of the moon. All primary mission objectives were successfully accomplished. In addition, all detailed test objectives plus four that were not originally scheduled, were successfully accomplished. Ten orbits of the moon were successfully performed, with the last eight at an altitude of approximately 60 NM. Television and photographic coverage was successfully carried out, with telecasts to the public being made in real time.

The Apollo 9 Mission was successfully launched on 3 March and completed on 13 March 1969. This was the second manned Saturn V flight, the third flight of a manned Apollo Command/Service Module, and the first flight of a manned Lunar Module. This flight provided the first manned LM systems performance demonstration. All primary mission objectives were successfully accomplished. All detailed test objectives were accomplished except two associated with S-band and VHF communications which were partially accomplished. The S-IVB second orbital restart, CSM transposition and docking, and LM rendezvous and docking were also successfully demonstrated.

The Apollo 10 Mission was successfully launched on 18 May 1969 and completed on 26 May 1969. This was the third manned Saturn V flight, the second flight of a manned Lunar Module, and the first mission to operate the complete Apollo Spacecraft around the moon. This mission provided operational experience for the crew, space vehicle, and mission-oriented facilities during a simulated lunar landing mission, which followed planned Apollo 11 mission operations and conditions as closely as possible without actually landing. All primary mission objectives and detailed test objectives were successfully accomplished. The manned navigational, visual, and excellent photographic coverage of Lunar Landing Sites 2 and 3 and of the range of possible landing sites in the Apollo belt highlands areas provided detailed support information for Apollo 11 and other future lunar landing missions.

NASA OMSF PRIMARY MISSION OBJECTIVES

FOR APOLLO 11

PRIMARY OBJECTIVE

- Perform a manned lunar landing and return.

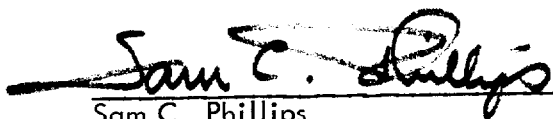

Sam C. Phillips  
Lt. General, USAF  
Apollo Program Director

Date: June 26, 1969.



George E. Mueller  
Associate Administrator for  
Manned Space Flight

Date: June 26, 1969

## DETAILED OBJECTIVES AND EXPERIMENTS

The detailed objectives and experiments listed below have been assigned to the Apollo 11 Mission. There are no launch vehicle detailed objectives or spacecraft mandatory and principal detailed objectives assigned to this mission.

	<u>NASA CENTER IDENTIFICATION</u>
● Collect a Contingency Sample.	A
● Egress from the LM to the lunar surface, perform lunar surface EVA operations, and ingress into the LM from the lunar surface.	B
● Perform lunar surface operations with the EMU.	C
● Obtain data on effects of DPS and RCS plume impingement on the LM and obtain data on the performance of the LM landing gear and descent engine skirt after touchdown.	D
● Obtain data on the lunar surface characteristics from the effects of the LM landing.	E
● Collect lunar Bulk Samples.	F
● Determine the position of the LM on the lunar surface.	G
● Obtain data on the effects of illumination and contrast conditions on crew visual perception.	H
● Demonstrate procedures and hardware used to prevent back contamination of the earth's biosphere.	I
● Passive Seismic Experiment.	S-031
● Laser Ranging Retro-Reflector.	S-078
● Solar Wind Composition.	S-080
● Lunar Field Geology.	S-059
● Obtain television coverage during the lunar stay period.	L
● Obtain photographic coverage during the lunar stay period.	M

## LAUNCH COUNTDOWN AND TURNAROUND CAPABILITY, AS-506

### COUNTDOWN

Countdown (CD) for launch of the AS-506 Space Vehicle (SV) for the Apollo 11 Mission will begin with a precount period starting at T-93 hours during which launch vehicle (LV) and spacecraft (S/C) CD activities will be conducted independently. Official coordinated S/C and LV CD will begin at T-28 hours and will contain two built-in holds; one of 11 hours 32 minutes at T-9 hours, and another of 1 hour at T-3 hours 30 minutes. Figure 3 shows the significant launch CD events.

### SCRUB/TURNAROUND

A termination (scrub) of the SV CD could occur at any point in the CD when launch support facilities, SV conditions, or weather warrant. The process of recycling the SV and rescheduling the CD (turnaround) will begin immediately following a scrub. The turnaround time is the minimum time required to recycle and count down the SV to T-0 (liftoff) after a scrub, excluding built-in hold time for launch window synchronization. For a hold that results in a scrub prior to T-22 minutes, turnaround procedures are initiated from the point of hold. Should a hold occur from T-22 minutes (S-II start bottle chilldown) to T-16.2 seconds (S-IC forward umbilical disconnect), then a recycle to T-22 minutes, a hold, or a scrub is possible under the conditions stated in the Launch Mission Rules. A hold between T-16.2 seconds and T-8.9 seconds (ignition) could result in either a recycle or a scrub depending on circumstances. An automatic or manual cutoff after T-8.9 seconds will result in a scrub.

Although an indefinite number of scrub/turnaround cases could be identified, six base-line cases have been selected to provide the flexibility required to cover probable contingencies. These cases identify the turnaround activities necessary to maintain the same confidence for subsequent launch attempts as for the original attempt. The six cases, shown in Figure 4, are discussed below.

#### Case 1 - Scrub/Turnaround at Post-LV Cryogenic Loading - Command/Service Module (CSM)/Lunar Module (LM) Cryogenic Reservicing.

**Condition:** The scrub occurs during CD between T-16.2 and T-8.9 seconds and all SV ordnance items remain connected except the range safety destruct safe and arm (S&A) units. Reservicing of the CSM cryogenics and LM supercritical helium (SHe) is required in addition to the recycling of the LV.

**Turnaround Time:** Turnaround would require 65 hours consisting of 37 hours for recycle time and 28 hours for countdown time. The time required for a Case 1 turnaround results from flight crew egress, LV cryogenic unloading, LV ordnance operations and battery

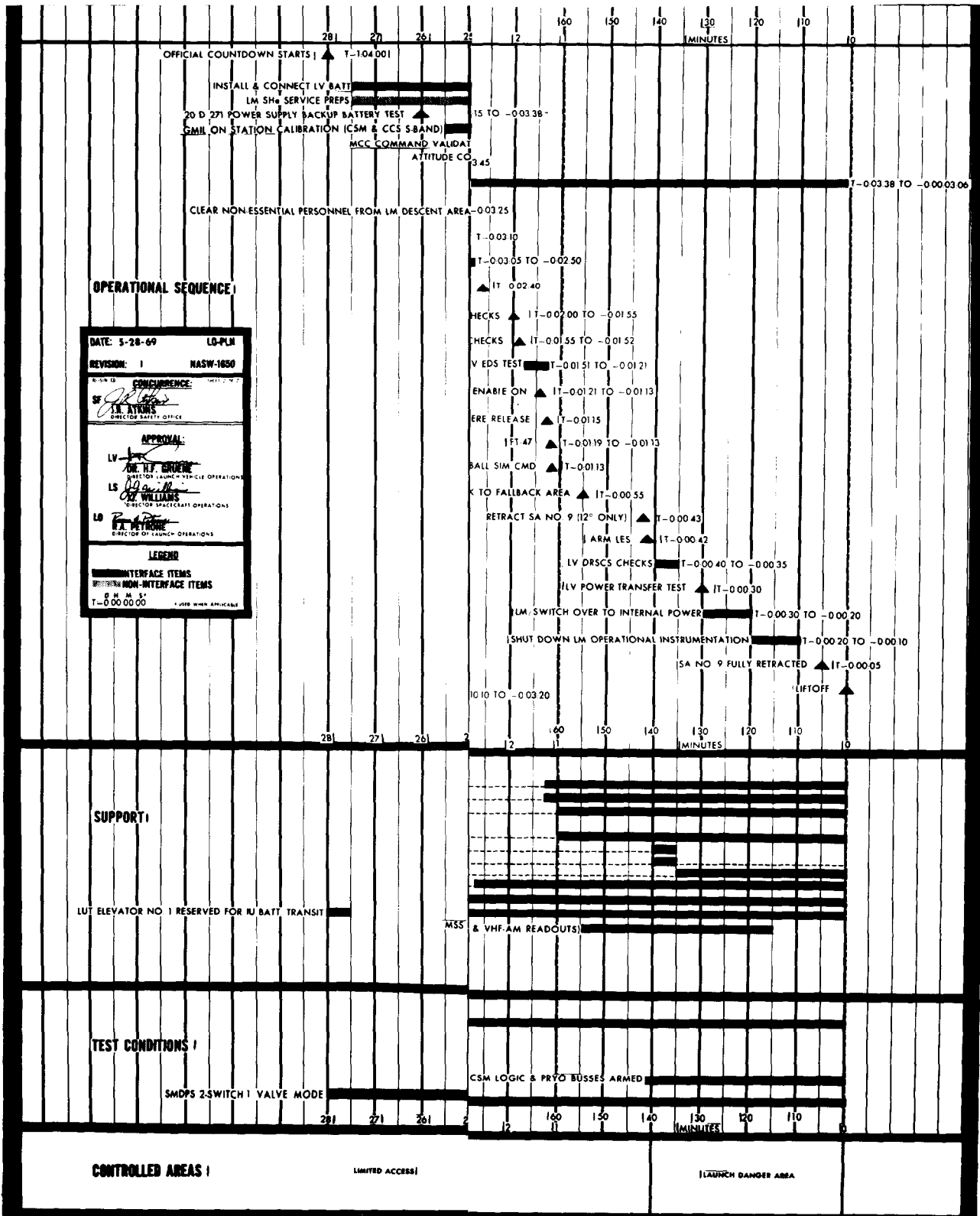

6/24/69

Fig. 3



# TURNAROUND FROM SCRUB, AS-506

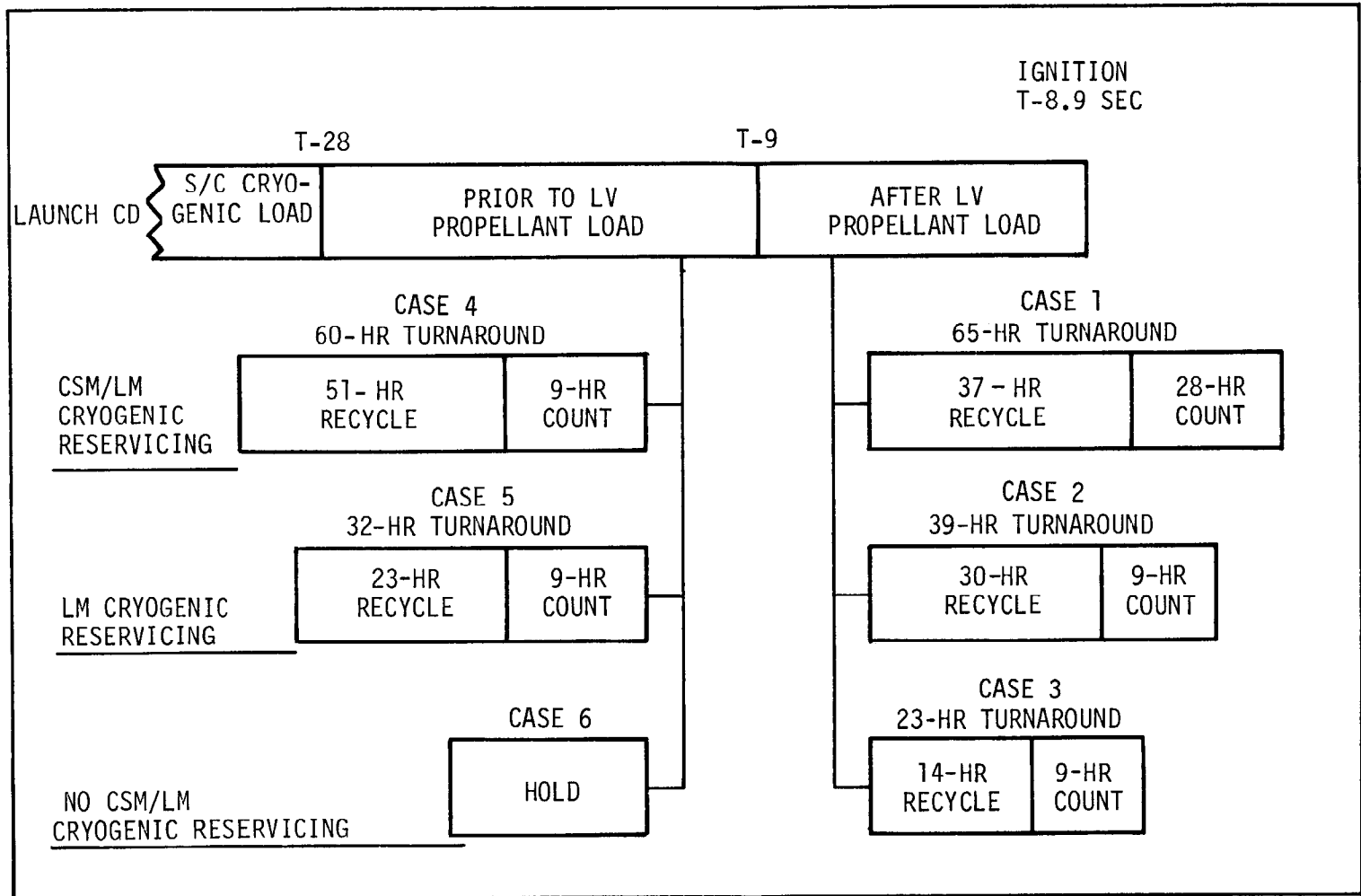

Fig. 4

removal, LM SHe reservicing, CSM cryogenic reservicing, CSM battery removal and installation, and CD resumption at T-28 hours.

Case 2 - Scrub/Turnaround at Post-LV Cryogenic Loading - LM Cryogenic Reservicing

Condition: The scrub occurs during CD between T-16.2 and T-8.9 seconds. Launch vehicle activities are minimized since they fall within allowable time constraints. Reservicing of the LM SHe is required.

Turnaround Time: Turnaround would require 39 hours 15 minutes, consisting of 30 hours 15 minutes for recycle time and 9 hours for CD time. The time requirement for this turnaround case results from flight crew egress, LV cryogenic unloading, LM SHe reservicing, LV loading preparations, and CD resumption at T-9 hours.

Case 3 - Scrub/Turnaround at Post-LV Cryogenic Loading - No CSM/LM Cryogenic Reservicing

Condition: The scrub occurs between T-16.2 and T-8.9 seconds in the CD. Launch vehicle recycle activities are minimized since they fall within allowable time constraints. LM SHe reservicing is not required.

Turnaround Time: Turnaround would require approximately 23 hours 15 minutes, consisting of 14 hours 15 minutes for recycle and 9 hours for CD time. The time required for this case results from flight crew egress, LV cryogenic unloading, S-IC forward umbilical installation and retest, LV propellant preparations, and CD resumption at T-9 hours.

Case 4 - Scrub/Turnaround at Pre-LV Cryogenic Loading - CSM/LM Cryogenic Reservicing

Condition: The scrub occurs at T-8 hours 15 minutes in the CD. The LV requires minimum recycle activities due to the point of scrub occurrence in the CD. The CSM cryogenics require reservicing and the CSM batteries require changing. The LM SHe cryogenics require reservicing. S-II servoactuator inspection is waived.

Turnaround Time: Turnaround would require approximately 59 hours 45 minutes, consisting of 50 hours 45 minutes for recycle and 9 hours for CD. The time required for this turnaround results from CSM cryogenic reservicing, CSM battery removal and installation, LM SHe reservicing, and CD resumption at T-9 hours.

Case 5 - Scrub/Turnaround at Pre-LV Cryogenic Loading - LM Cryogenic Reservicing

Condition: The scrub occurs at T-8 hours 15 minutes in the CD. The SV can remain closed out, except inspection of the S-II servoactuator is waived and the Mobile Service Structure is at the pad gate for reservicing of the LM SHe.

Turnaround Time: Turnaround would require approximately 32 hours, consisting of 23 hours for recycle time and 9 hours for CD. This case provides the capability for an approximate 1-day turnaround that exists at T-8 hours 15 minutes in the CD. This capability permits a launch attempt 24 hours after the original T-0. The time required for this turnaround results from LM SHe reservicing and CD resumption at T-9 hours.

Case 6 - Scrub/Turnaround at Pre-LV Cryogenic Loading - No LM/CSM Cryogenic Reservicing

Condition: A launch window opportunity exists 1 day after the original T-0. The LV, LM, and CSM can remain closed out.

Turnaround Time: Hold for the next launch window. The possibility for an approximate 1-day hold may exist at T-8 hours 15 minutes in the CD.

In the event of a scrub, the next possible attempt at a given launch window will depend on the following:

1. The type of scrub/turnaround case occurrence and its time duration.
2. Real-time factors that may alter turnaround time.
3. The number of successive scrubs and the case type of each scrub occurrence.
4. Specific mission launch window opportunities.

Figure 5 shows the scrub/turnaround possibilities in the Apollo 11 Mission for a July launch window. Since the turnaround time may fall short of or exceed a launch window, hold capabilities necessary to reach the closest possible launch window must be considered. Possible hold points are between recycle and CD, and at T-9 hours in the CD (as in the original CD).

In the event of two successive scrub/turnarounds, SV constraints may require that additional serial or parallel tasks be performed in the second scrub/turnaround case. The 36 possible combinations of the baseline cases and the constraints that may develop on the second turnaround case occurrence are shown in the second scrub/turnaround matrix (Figure 6). A second scrub/turnaround will require that real-time considerations be given either to additional task performance or to task waivers.

6/24/69

# SCRUB/TURNAROUND POSSIBILITIES, AS 506 JULY LAUNCH WINDOW

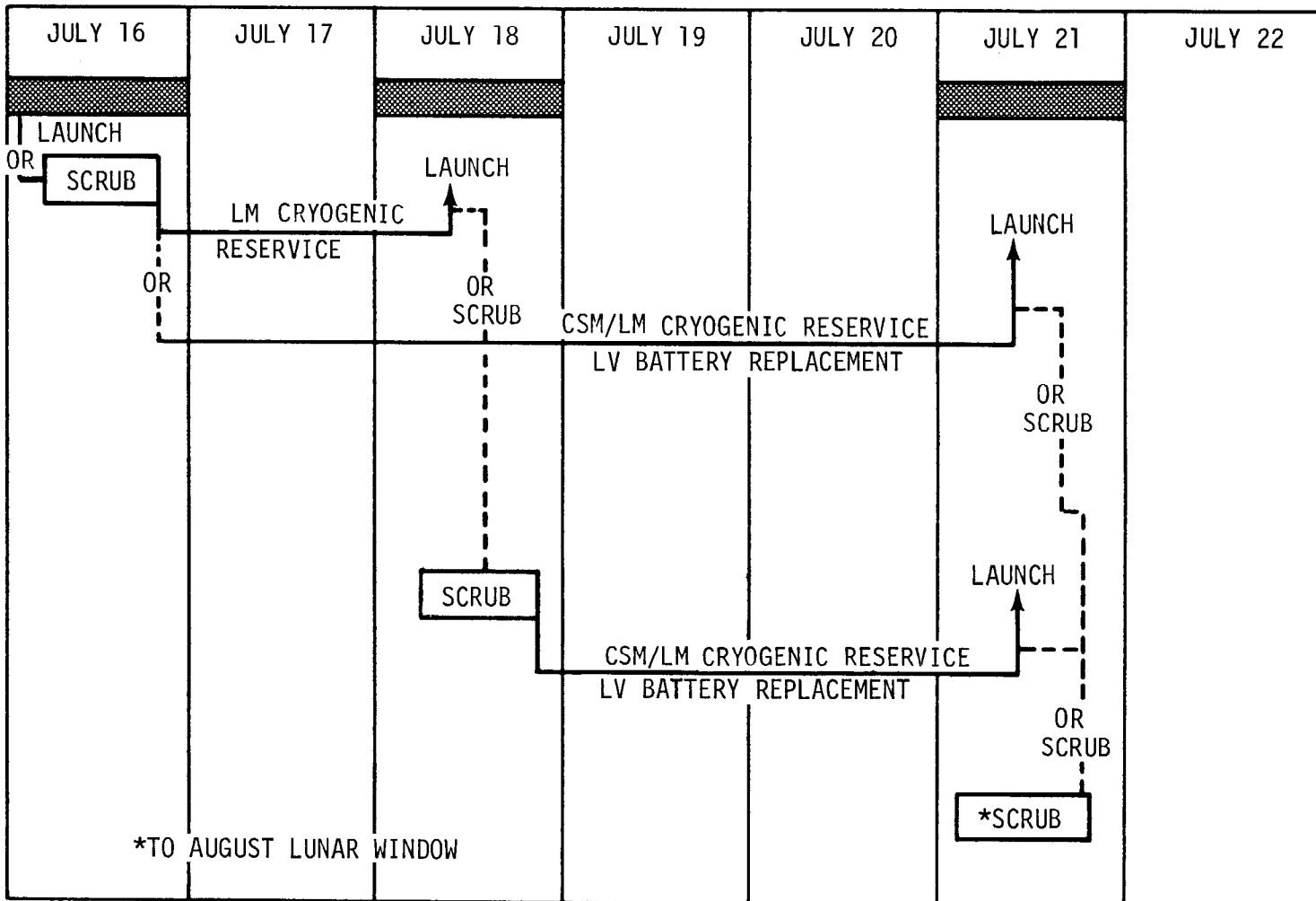

Page 14

Fig. 5

M-932-69-11

SECOND SCRUB/TURNAROUND MATRIX, AS-506

		FIRST SCRUB/TURNAROUND					
		CASE 1	CASE 2	CASE 3	CASE 4	CASE 5	CASE 6
SECOND SCRUB/TURNAROUND	CASE 1	YES	YES	YES	YES	YES	YES
	CASE 2	YES	NO A,C,D	NO A,C,D	NO A,C,D	NO A,C,D	NO A,C,D
	CASE 3	YES	NO A,C,D	NO A,B,C	NO D	NO A,C	NO A,B,C
	CASE 4	YES	NO D	NO D	NO D	NO D	NO D
	CASE 5	YES	NO A,C,D	NO A,C	NO D	NO A,C	NO A,C
	CASE 6	YES	NO A,C,D	NO A,B,C	NO D	NO A,C	NO A,B,C

LEGEND

A YES IN THE MATRIX BLOCK INDICATES NO IDENTIFIABLE CONSTRAINTS ARE APPARENT.

A NO FOLLOWED BY ONE OR MORE LETTERS IN THE MATRIX BLOCK INDICATES THAT SOME CONSTRAINT(S), AS IDENTIFIED BELOW, IS APPARENT:

- A. THE CSM CRYOGENICS MAY REQUIRE RESERVICING.
- B. THE LM SHE MAY REQUIRE RESERVICING.
- C. THE CSM BATTERIES MAY REQUIRE CHANGING.
- D. THE LV BATTERIES WILL REQUIRE CHANGING.

Fig. 6

DETAILED FLIGHT MISSION DESCRIPTIONLAUNCH WINDOWS

Apollo 11 has two types of launch windows. The first, a monthly launch window, defines the days of the month when launch can occur, and the second, a daily launch window, defines the hours of these days when launch can occur.

Monthly Launch Window

Since this mission includes a lunar landing, the flight is designed such that the sun is behind the Lunar Module (LM) and low on the eastern lunar horizon in order to optimize visibility during the LM approach to one of the three Apollo Lunar Landing Sites available during the July monthly launch window. Since a lunar cycle is approximately 28 earth days long, there are only certain days of the month when these landing sites are properly illuminated. Only one launch day is available for each site for each month. Therefore, the Apollo 11 launch must be timed so that the spacecraft will arrive at the moon during one of these days. For a July 1969 launch, the monthly launch window is open on the 16th, 18th, and 21st days of the month. The unequal periods between these dates are a result of the spacing between the selected landing sites on the moon. Table 2 shows the opening and closing of the monthly launch windows and the corresponding sun elevation angles. Figure 7 shows the impact of July launch windows on mission duration.

TABLE 2

MONTHLY LAUNCH WINDOWS

<u>Site</u>	<u>Date</u>	<u>July (EDT)</u> <u>Open-Close**</u>	<u>SEA***</u>	<u>Date</u>	<u>August (EDT)</u> <u>Open-Close**</u>	<u>SEA</u>
2	16	09:32-13:54	10.8°	14H	07:45-12:15	6.0°
3	18H*	11:32-14:02	11.0°	16H	07:55-12:25	6.0°
5	21H	12:09-14:39	9.1°	20H	09:55-14:35	10.0°

\*Hybrid (H) trajectory used.

\*\*Based on 108° launch azimuth upper limit.

\*\*\*Sun Elevation Angle (SEA) - assumes launch at window opening and translunar injection at the first opportunity.

NOTE: A hybrid trajectory is required for a launch on 18 July to make it possible for the Goldstone tracking station 210-foot antenna to cover the LM powered descent phase.

## MISSION DURATIONS, JULY LAUNCH WINDOWS

Daily Launch Windows

The maneuver to transfer the S-IVB/spacecraft from earth parking orbit to a translunar trajectory must be performed over a point called the moon's antipode. This is a point on the earth's surface where an imaginary line, drawn from the moon's position (at expected spacecraft arrival time) through the center of the earth, will intersect the far side of the earth. In other words, it is the point on the earth that is exactly opposite the moon. Since the moon revolves around the earth and the earth is spinning on its axis, the antipode is constantly moving. This presents the problem of having the S-IVB/spacecraft rendezvous with a moving target, the antipode, before it can perform the translunar injection (TLI) burn. Additional constraints on the execution of this maneuver are:

(1) it will be performed over the Pacific Ocean, (2) it can occur no earlier than revolution 3 because of S-IVB systems lifetime. These constraints, combined with a single fixed launch azimuth, allow only a very short period of time each day that launch can be performed.

To increase the amount of time available each day, and still maintain the capability to rendezvous with the antipode, a variable launch azimuth technique will be used. The launch azimuth increases approximately  $8^\circ$  per hour during the launch window, and the variation is limited by range safety considerations to between  $72^\circ$  and  $106^\circ$ . This extends the time when rendezvous with the projected antipode can be accomplished up to a maximum of approximately 4.5 hours. The minimum daily launch window for Apollo 11 is approximately 2.5 hours.

FREE-RETURN/HYBRID TRAJECTORY

A circumlunar free-return trajectory, by definition, is one which circumnavigates the moon and returns to earth. The perigee altitude of the return trajectory is of such a magnitude that by using negative lift the entering spacecraft can be prevented from skipping out of the earth's atmosphere, and the aerodynamic deceleration can be kept below 10 g's. Thus, even with a complete propulsion system failure following TLI, the spacecraft would return safely to earth. However, free-return trajectory severely limits the accessible area on the moon because of the very small variation in allowable lunar approach conditions and because the energy of the lunar approach trajectory is

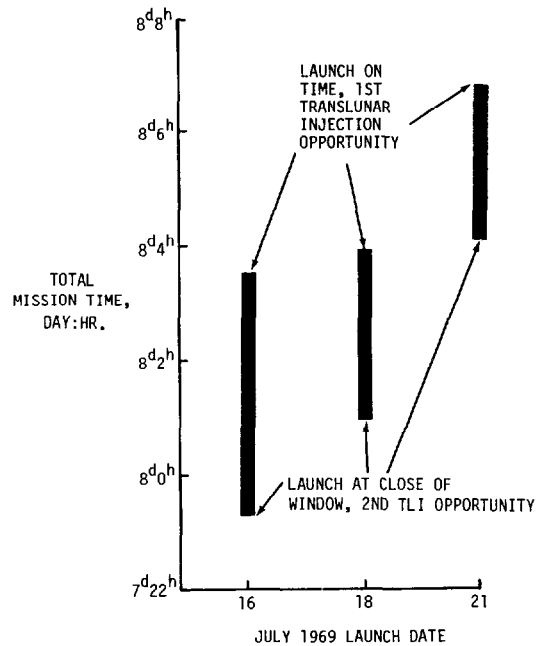

Fig. 7

relatively high. The high approach energy causes the orbit insertion velocity change requirement ( $\Delta V$ ) to be relatively high.

Since the free-return flight plan is so constraining on the accessible lunar area, hybrid trajectories have been developed that retain most of the safety features of the free return, but do not suffer from the performance penalties. If a hybrid trajectory is used for Apollo 11, the spacecraft will be injected into a highly eccentric elliptical orbit which had the free-return characteristic; i.e., a return to the entry corridor without any further maneuvers. The spacecraft will not depart from the free-return ellipse until spacecraft ejection from the launch vehicle has been completed. After the Service Propulsion System (SPS) has been checked out, a midcourse maneuver will be performed by the SPS to place the spacecraft on a lunar approach trajectory. The resulting lunar approach will not be on a free-return trajectory, and hence will not be subject to the same limitations in trajectory geometry.

On future Apollo lunar missions, landing sites at higher latitudes will be achieved, with little or no plane change, by approaching the moon on a highly inclined trajectory.

### LUNAR LANDING SITES

The following Lunar Landing Sites, as shown in Figure 8, are final choices for Apollo 11:

Site 2      latitude 0°41' North  
                 longitude 23°43' East

Site 2 is located on the east central part of the moon in southwestern Mare Tranquillitatis.

Site 3      latitude 0°21' North  
                 longitude 1°18' West

Site 3 is located near the center of the visible face of the moon in the southwestern part of Sinus Medii.

Site 5      latitude 1°41' North  
                 longitude 41°54' West

Site 5 is located on the west central part of the visible face in southeastern Oceanus Procellarum.



APOLLO LUNAR LANDING SITES

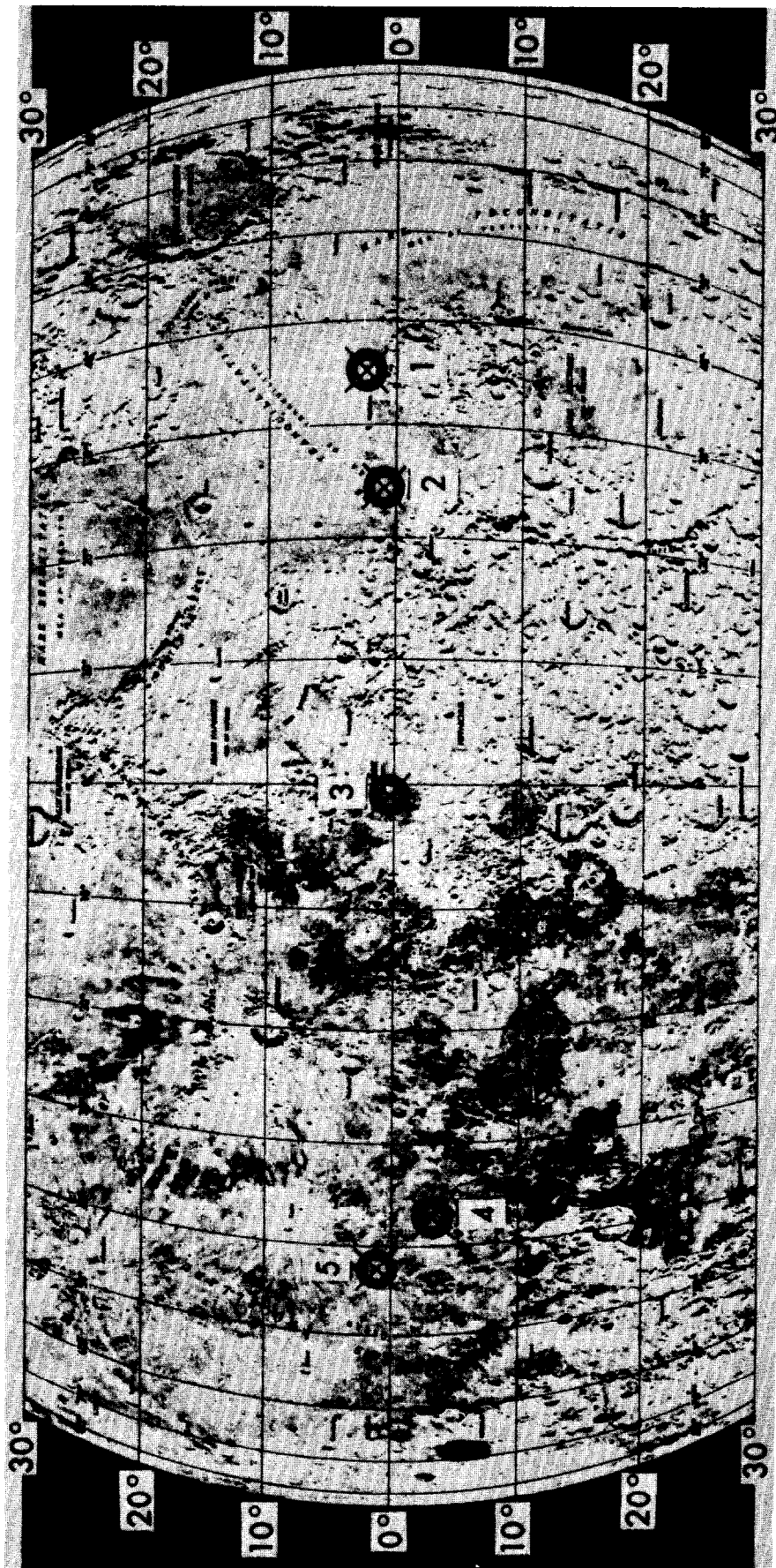

The final site choices were based on these factors:

- Smoothness (relatively few craters and boulders).
- Approach (no large hills, high cliffs, or deep craters that could cause incorrect altitude signals to the Lunar Module landing radar).
- Propellant requirements (selected sites require the least expenditure of spacecraft propellants).
- Recycle (selected sites allow effective launch preparation recycling if the Apollo/Saturn V countdown is delayed).
- Free-return (sites are within reach of the spacecraft launched on a free-return translunar trajectory).
- Slope (there is little slope — less than 2 degrees in the approach path and landing area).

## FLIGHT PROFILE

### Launch to Earth Parking Orbit

The Apollo 11 Space Vehicle is planned to be launched at 09:32 EDT from Complex 39A at the Kennedy Space Center, Florida, on a launch azimuth of 72°. The space vehicle (SV) launch weight breakdown is shown in Table 3. The Saturn V boost to earth parking orbit (EPO), shown in Figure 9, will consist of a full burn of the S-IC and S-II stages and a partial burn of the S-IVB stage of the Saturn V Launch Vehicle. Insertion into a 103-nautical mile (NM) EPO (inclined approximately 33 degrees from the earth's equator) will occur approximately 11.5 minutes ground elapsed time (GET) after liftoff. The vehicle combination placed in earth orbit consists of the S-IVB stage, the Instrument Unit (IU), the Lunar Module (LM), the Spacecraft-LM Adapter (SLA), and the Command/Service Module (CSM). While in EPO, the S-IVB and spacecraft will be readied for the second burn of the S-IVB to achieve the translunar injection (TLI) burn. The earth orbital configuration of the SV is shown in Figure 10.

### Translunar Injection

The S-IVB J-2 engine will be reignited during the second parking orbit (first opportunity) to inject the SV combination into a translunar trajectory. The second opportunity for TLI will occur on the third parking orbit. The TLI burn will be biased for a small over-burn to compensate for the Service Propulsion System (SPS) evasive maneuver that will be performed after ejection of the LM/CSM from the S-IVB/IU/SLA.

TABLE 3  
APOLLO 11 WEIGHT SUMMARY  
 (Weight in Pounds)

STAGE/MODULE	INERT WEIGHT	TOTAL EXPENDABLES	TOTAL WEIGHT	FINAL SEPARATION WEIGHT
S-IC Stage	288,750	4,739,320	5,028,070	363,425
S-IC/S-II Interstage	11,465	-----	11,465	-----
S-II Stage	79,920	980,510	1,060,430	94,140
S-II/S-IVB Interstage	8,080	-----	8,080	-----
S-IVB Stage	25,000	237,155	262,155	28,275
Instrument Unit	4,305	-----	4,305	-----
Launch Vehicle at Ignition			6,374,505	
Spacecraft-LM Adapter	4,045	-----	4,045	-----
Lunar Module	9,520	23,680	33,200	*33,635
Service Module	10,555	40,605	51,160	11,280
Command Module	12,250	-----	12,250	11,020 (Landing)
Launch Escape System	8,910	-----	8,910	-----
Spacecraft At Ignition			109,565	
Space Vehicle at Ignition			6,484,070	
S-IC Thrust Buildup			(-) 85,845	
Space Vehicle at Liftoff			6,398,325	
Space Vehicle at Orbit Insertion			292,865	

\* CSM/LM Separation

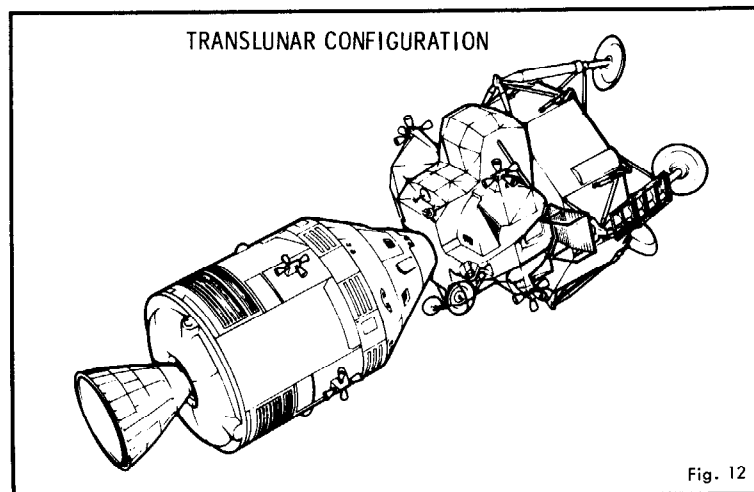
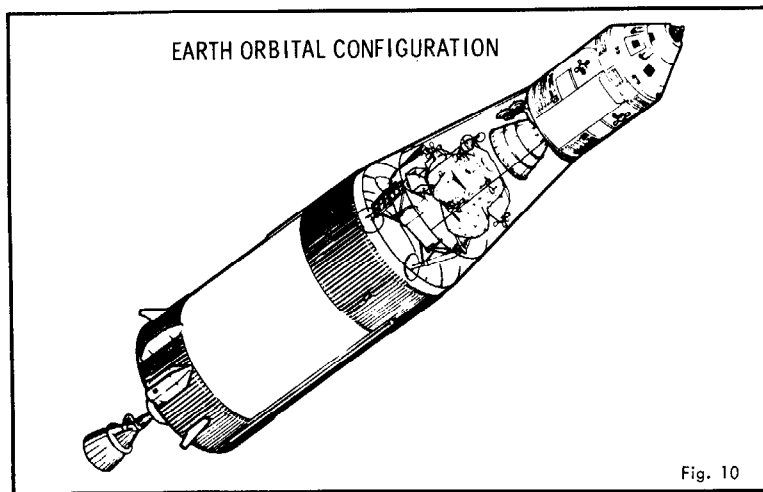
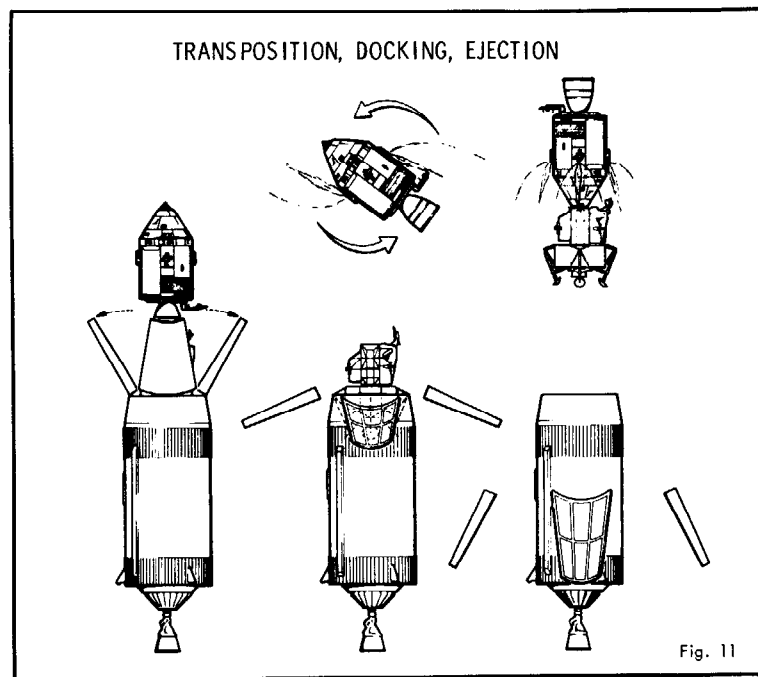
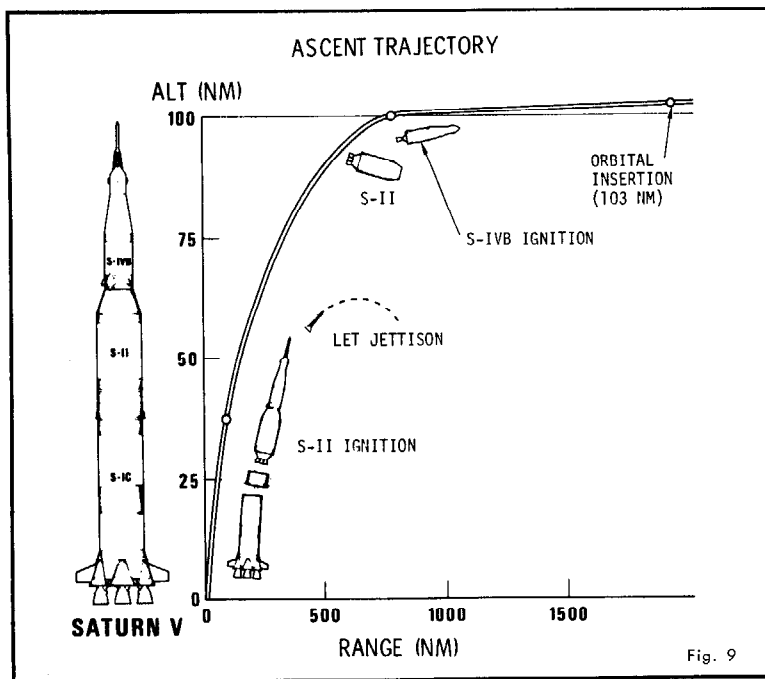

## Translunar Coast

Within 2.5 hours after TLI, the CSM will be separated from the remainder of the vehicle and will transpose, dock with the LM, and initiate ejection of the CSM/LM from the SLA/IU/S-IVB as shown in Figure 11. A pitchdown maneuver of a prescribed magnitude for this transposition, docking, and ejection (TD&E) phase is designed to place the sun over the shoulders of the crew, avoiding CSM shadow on the docking interface. The pitch maneuver also provides continuous tracking and communications during the inertial attitude hold during TD&E.

At approximately 1 hour 45 minutes after TLI, a spacecraft evasive maneuver will be performed using the SPS to decrease the probability of S-IVB recontact, to avoid ice particles expected to be expelled by the S-IVB during LOX dump, and to provide an early SPS confidence burn. This SPS burn will be performed in a direction and of a duration and magnitude that will compensate for the TLI bias mentioned before. The evasive maneuver will place the docked spacecraft, as shown in Figure 12, on a free return circumlunar trajectory. A free return to earth will be possible if the insertion into lunar parking orbit cannot be accomplished.

Approximately 2 hours after TLI, the residual propellants in the S-IVB are dumped to perform a retrograde maneuver. This "slingshot" maneuver reduces the probability of S-IVB recontact with the spacecraft and results in a trajectory that will take the S-IVB behind the trailing edge of the moon into solar orbit, thereby avoiding both lunar impact and earth impact.

Passive thermal control attitude will be maintained throughout most of the translunar coast period. Four midcourse correction maneuvers are planned and will be performed only if required. They are scheduled to occur at approximately TLI plus 9 hours, TLI plus 24 hours, lunar orbit insertion (LOI) minus 22 hours, and LOI minus 5 hours. These corrections will use the Manned Space Flight Network (MSFN) for navigation. The translunar coast phase will span approximately 73 hours.

## Lunar Orbit Insertion

LOI will be performed in two separate maneuvers using the SPS of the CSM as shown in Figure 13. The first maneuver, LOI-1, will be initiated after the spacecraft has passed behind the moon and crosses the imaginary line through the centers of the earth and moon at approximately 80 NM above the lunar surface. The SPS burn is a retrograde maneuver that will place the spacecraft into an elliptical orbit that is approximately 60 x 170 NM. After two revolutions in the 60 x 170-NM orbit and a navigation update, a second SPS retrograde burn (LOI-2) will be made as the spacecraft crosses the antipode behind the moon to place the spacecraft in an elliptical orbit approximately 55 x 65 NM. This orbit will become circularized at 60 NM by the time of LM rendezvous due to the effect of variations in the lunar gravitational potential on the spacecraft as it orbits the moon.

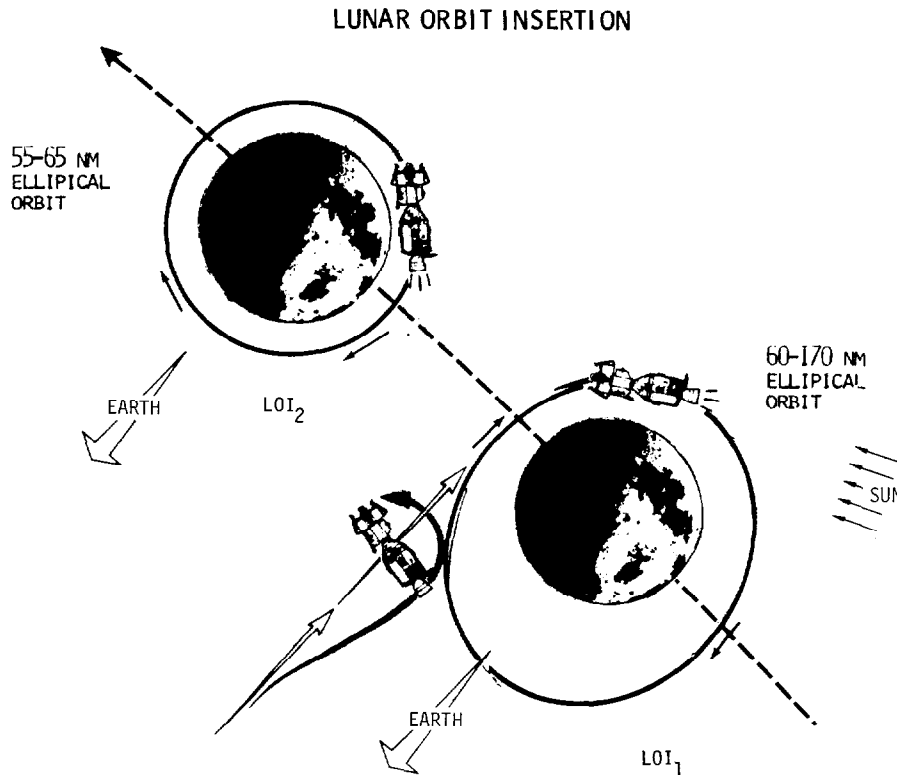

### CSM/LM Coast to LM Powered Descent

After LOI-2, some housekeeping will be accomplished in both the CSM and the LM. Subsequently, a simultaneous rest and eat period of approximately 10 hours will be provided for the three astronauts prior to checkout of the LM. Then the Commander (CDR) and Lunar Module Pilot (LMP) will enter the LM, perform a thorough check of all systems, and undock from the CSM. During the 13th revolution after LOI-2 and approximately 2.5 hours before landing, the LM and CSM will undock in preparation for descent. The undocking is a physical unlatching of a spring-loaded mechanism that imparts a relative velocity of approximately 0.5 feet per second (fps) between the vehicles. Station-keeping is initiated at a distance of 40 feet, and the LM is rotated about its yaw axis for CM Pilot observation of the deployed landing gear. Approximately one-half hour after undocking, the SM Reaction Control System (RCS) will be used to perform a separation maneuver of approximately 2.5 fps directed radially downward toward the center of the moon. This maneuver increases the LM/CSM separation distance to approximately 2.2 NM at descent orbit insertion (DOI). The DOI maneuver will be performed by a LM DPS retrograde burn, as shown in Figure 14, one-half revolution after LM/CSM separation. This maneuver places the LM in an elliptical orbit that is approximately 60 NM by 50,000 feet. The descent orbit events are shown in Figure 15.

### DESCENT ORBIT INSERTION



Fig. 14

### LUNAR MODULE DESCENT

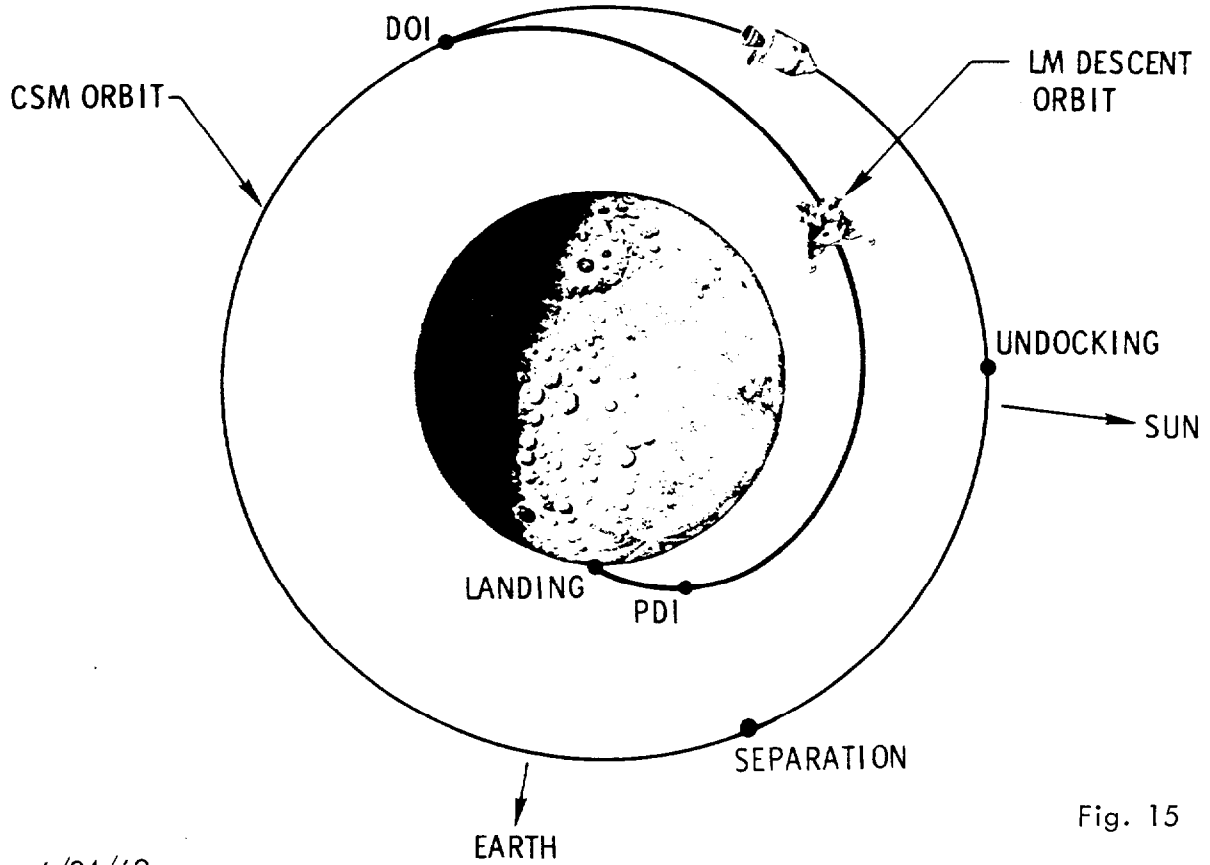

Fig. 15

6/24/69

EARTH

### Lunar Module Powered Descent

The LM powered descent maneuver will be initiated at the 50,000-foot altitude point of the descent orbit and approximately  $14^\circ$  prior to the landing site. This maneuver will consist of a braking phase, an approach phase, and a landing phase. The braking phase will use maximum thrust from the DPS for most of this phase to reduce the LM's orbital velocity. The LM will be rotated to a windows-up attitude at an altitude of 45,000 feet. The use of the landing radar can begin at an altitude of about 39,000 feet, as depicted in Figure 16. The approach phase, as shown in Figure 17, will begin at approximately 7600 feet (high gate) from the lunar surface. Vehicle attitudes during this phase will permit crew visibility of the landing area through the forward window. The crew can redesignate to an improved lunar surface area in the event the targeted landing point appears excessively rough. The landing phase will begin at an altitude of 500 feet (low gate) and has been designed to provide continued visual assessment of the landing site. The crew will take control of the spacecraft attitude and make minor adjustments as required in the rate of descent during this period.

The vertical descent portion of the landing phase will start at an altitude of 125 feet and continue at a rate of 3 fps until the probes on the foot pads of the LM contact the lunar surface. The CDR will cut off the descent engine within 1 second after the probes, which extend 68 inches beyond the LM footpad, contact the lunar surface although the descent engine can be left on until the footpads contact the lunar surface. The lunar surface contact sequence is shown in Figure 18.

### LANDING RADAR-ANTENNA BEAM CONFIGURATION

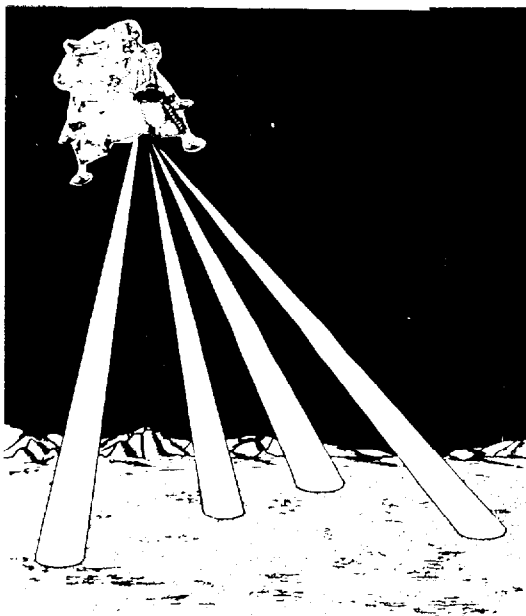

APPROACH PHASE

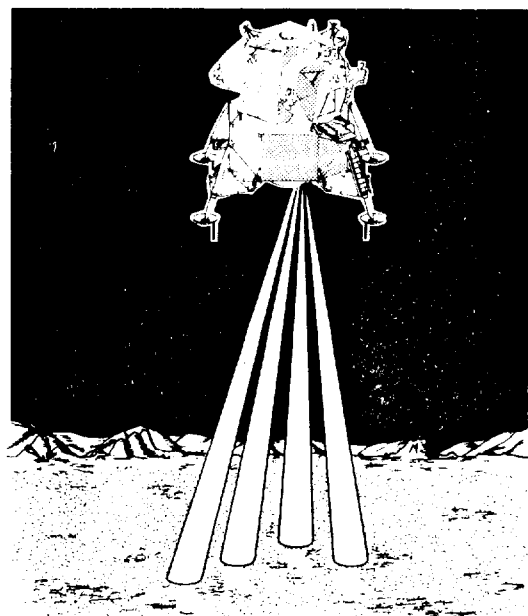

LANDING PHASE

6/24/69



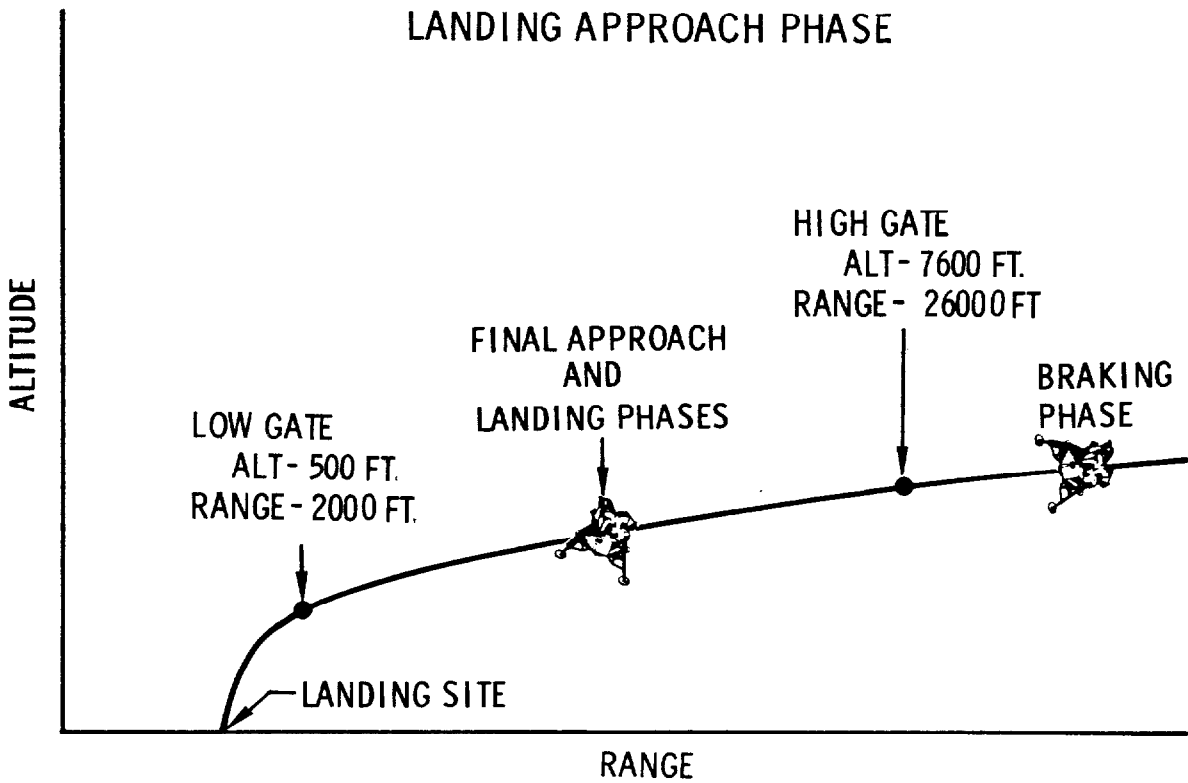

Fig. 17

### LUNAR CONTACT SEQUENCE

- PROBE CONTACTS LUNAR SURFACE
- 'LUNAR CONTACT' INDICATOR ON CONTROL PANEL LIGHTS
- DESCENT ENGINE IS SHUT DOWN BY CREW AFTER 1 SECOND
- LM SETTLES TO LUNAR SURFACE

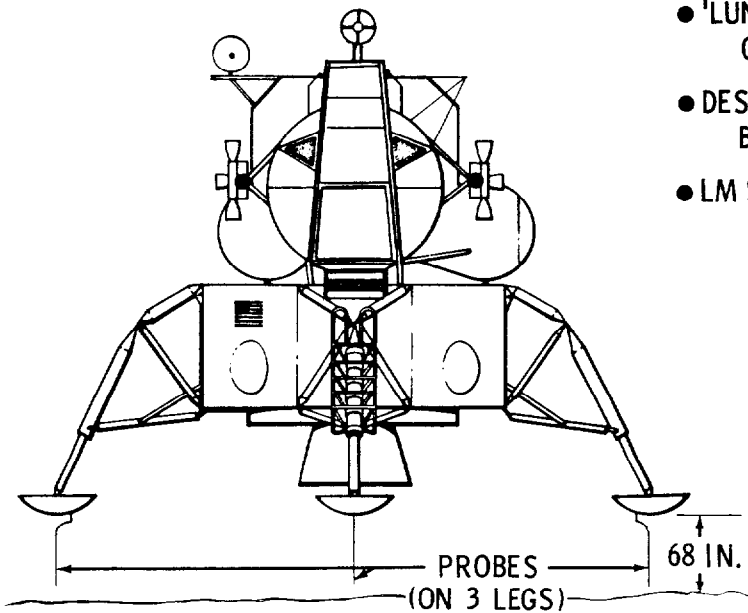

Fig. 18

### Lunar Surface Activities

Immediately after landing, the LM will be checked to assess its launch capability. After the postlanding checks and prior to preparation for extravehicular activity (EVA), there will be a 4-hour rest period, with eat periods before and after. A timeline for the lunar surface activity is shown in Figure 19. Each crewman will then don a "back-pack" consisting of a Portable Life Support System (PLSS) and an Oxygen Purge System (OPS). The LM Environmental Control System (ECS) and the Extravehicular Mobility Unit (EMU) will be checked out, and the LM will be depressurized to allow the CDR to egress to the lunar surface. As the CDR begins to descend the LM ladder, he will pull a "D" ring which will lower the Modularized Equipment Stowage Assembly (MESA). This allows the TV camera mounted on the MESA access panel to record his descent to the lunar surface. The LMP will remain inside the LM Ascent Stage during the early part of the EVA to monitor the CDR's surface activity (including photography through the LM window) and the LM systems in the depressurized state.

### Commander Environmental Familiarization

Once on the surface, the CDR will move slowly from the footpad to check his balance and determine his ability to continue with the EVA — the ability to move and to see or, specifically, to perform the surface operations within the constraints of the EMU and the lunar environment. Although a more thorough evaluation and documentation of a crewman's capabilities will occur later in the timeline, this initial familiarization will assure the CDR that he and the LMP are capable of accomplishing the assigned EVA tasks. A brief check of the LM status will be made to extend the CDR's environment familiarization and, at the same time, provide an important contribution to the postflight assessment of the LM landing should a full or nominal LM inspection not be accomplished later.

### Contingency Sample Collection

A Contingency Sample of lunar surface material will be collected. This will assure the return of a small sample in a contingency situation where a crewman may remain on the surface for only a short period of time. One to four pounds of loose material will be collected in a sample container assembly which the CDR carries to the surface in his suit pocket. The sample will be collected near the LM ladder and the sample bag restowed in the suit pocket to be carried into the Ascent Stage when the CDR ingresses at the end of the EVA. Figure 20 shows the relative location of the Contingency Sample collection and the other lunar surface activities.

## LUNAR SURFACE ACTIVITY

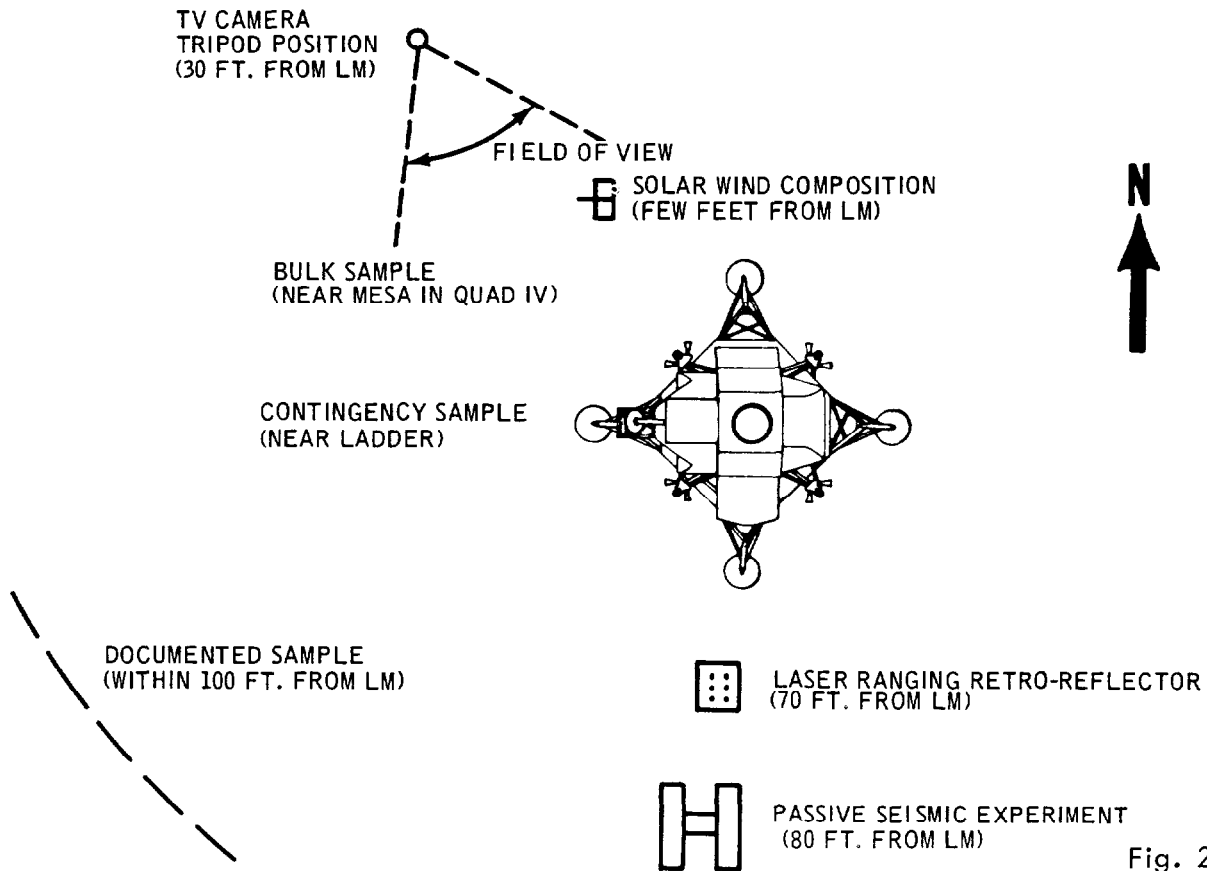

Fig. 20

S-Band Erectable Antenna Deployment

In the event that adequate margins do not exist with the steerable antenna for the entire communications spectrum (including television) during the EVA period, the S-band erectable antenna may be deployed to improve these margins. This would require approximately 19 minutes and will probably reduce the time allocated to other EVA events.

Lunar Module Pilot Environmental Familiarization

After the CDR accomplishes the preliminary EVA task, the LMP will descend to the surface and spend a few minutes in the familiarization and evaluation of his capability or limitations to conduct further operations in the lunar environment.

Television Camera Deployment

The CDR, after photographing the LMP's egress and descent to the surface, will remove the TV camera from the Descent Stage MESA, obtain a panorama, and place the camera on its tripod in a position to view the subsequent surface EVA operations. The TV camera will remain in this position.

### Extravehicular Activity and Environmental Evaluation

The LMP will proceed to conduct the environmental evaluation. This involves a detailed investigation and documentation of a crewman's capability within the constraints of the EMU; the PLSS/EMU performance under varying conditions of sunlight, shadow, crewman activity or inactivity; and the characteristics of the lunar environment which influence operations on the surface.

### Flag Deployment

Early in the LMP EVA period the astronauts will erect a 3 by 5-foot Americal flag. It will be on an 8-foot aluminum staff and a spring-like wire along its top edge will keep it unfurled in the airless environment of the moon. The event will be recorded on television and transmitted live to earth. The flag will be placed a sufficient distance from the LM to avoid damage by the ascent engine exhaust at lunar takeoff.

### Bulk Sample Collection

The CDR will collect a Bulk Sample of lunar surface material. In the Bulk Sample collection at least 22 pounds, but as much as 50 pounds, of unsorted surface material and selected rock chunks will be placed in a special container, a Lunar Sample Return Container (SRC), to provide a near vacuum environment for its return to the Lunar Receiving Laboratory (LRL). Apollo Lunar Handtools (ALHT), stowed in the MESA with the SRC, will be used to collect this large sample of loose lunar material from the surface near the MESA in Quad IV of the LM. Figure 21 shows the removal of tools stowed in the MESA. Figure 22 shows the preparation of a handtool for use. As each rock sample or scoop of loose material is collected, it will be placed into a large sample bag. Placing the sealed bag, rather than the loose material, directly into the SRC prevents contamination and possible damage to the container seals.

### Solar Wind Composition Experiment Deployment

The LMP will deploy the Solar Wind Composition (SWC) experiment. The SWC experiment consists of a panel of very thin aluminum foil rolled and assembled into a combination handling and deployment container. It is stowed in the MESA. Once the thermal blanket is removed from around the MESA equipment it is a simple task to remove the SWC, deploy the staff and the foil "window shade," and place it in direct sunlight where the foil will be exposed to the sun's rays, as shown in Figure 23. The SWC experiment is designed to entrap noble gas constituents of the solar wind, such as helium, neon, argon, krypton, and xenon. It is deployed early in the EVA period for maximum exposure time. At the conclusion of the EVA, the foil is rolled up, removed from the staff, and placed in a SRC. At the time the foil is recovered, the astronaut will push the staff into the lunar surface to determine, for postflight soil mechanics analysis, the depth of penetration.

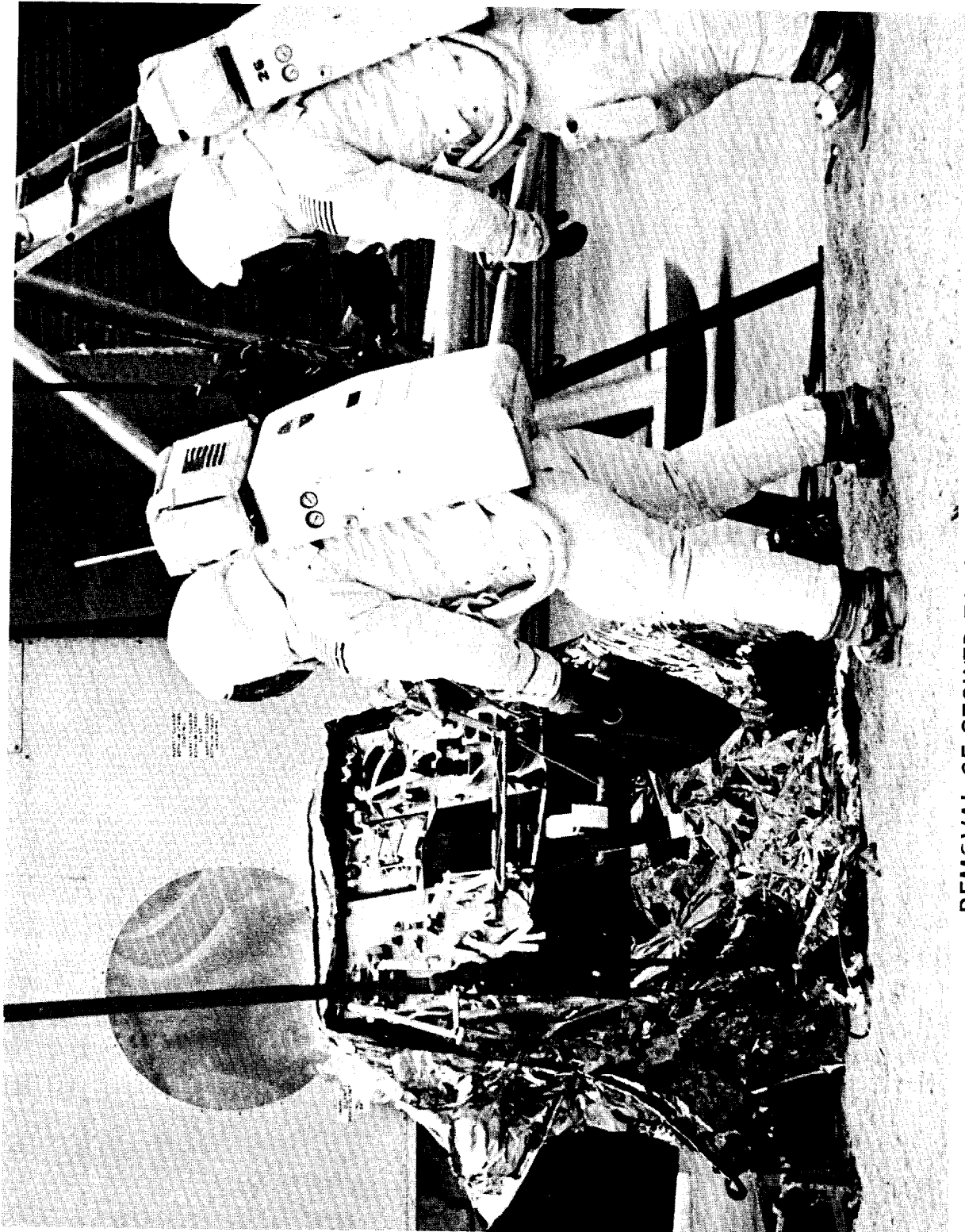

REMOVAL OF STOWED TOOLS FROM MESA

Fig. 21



PREPARATION OF HAND TOOL

Fig. 22

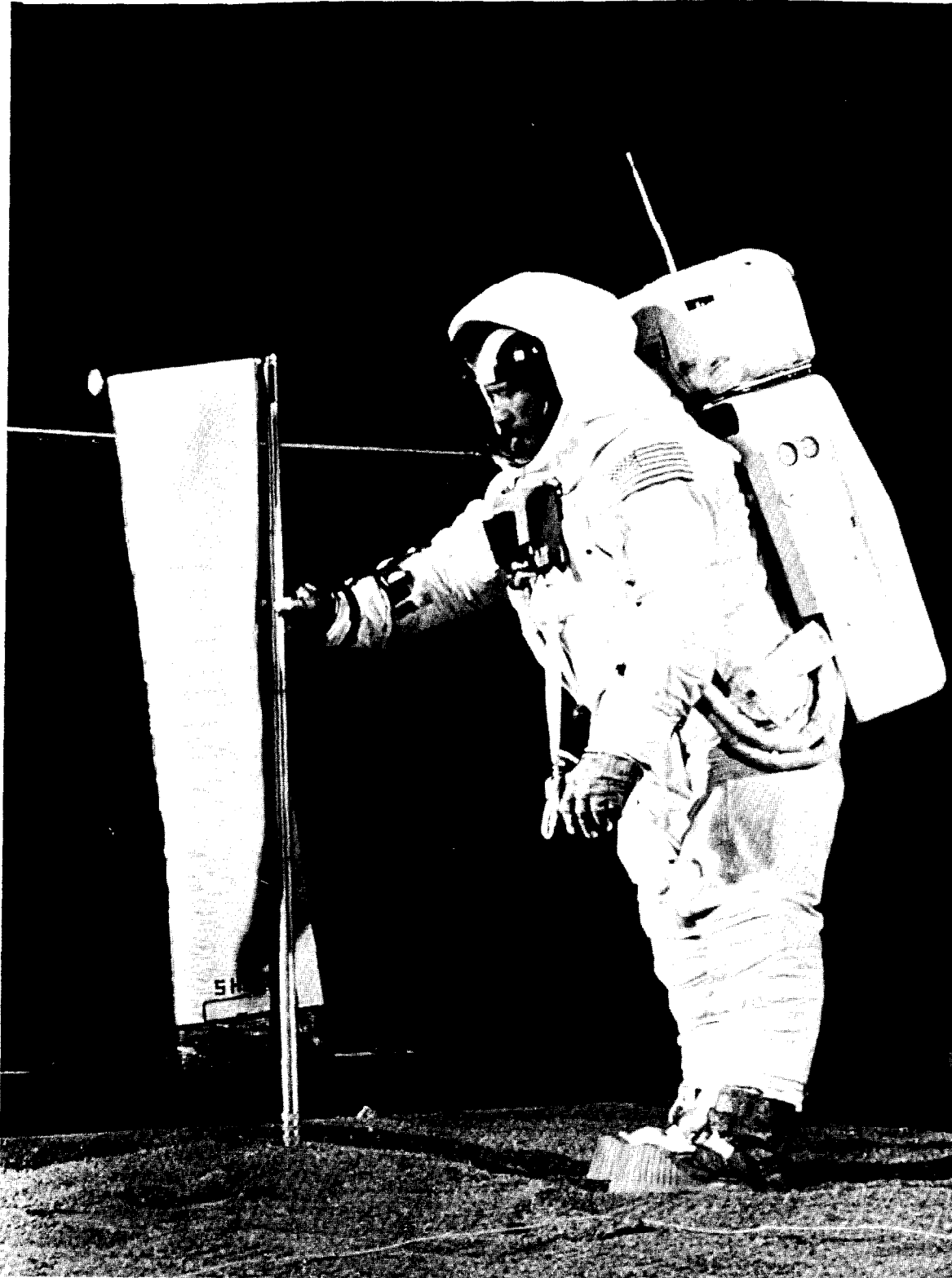

DEPLOYED SOLAR WIND COMPOSITION EXPERIMENT

Fig. 23

6/24/69

Page 34

### Lunar Module Inspection

The LMP will begin the LM inspection and will be joined by the CDR after the Bulk Samples have been collected. The purpose of the LM inspection is to visually check and photographically document the external condition of the LM landing on the lunar surface. The inspection data will be used to verify the LM as a safe and effective vehicle for lunar landings. The data will also be used to gain more knowledge of the lunar surface characteristics. In general the results of the inspection will serve to advance the equipment design and the understanding of the environment in which it operates. The crewmen will methodically inspect and report the status of all external parts and surfaces of the LM which are visible to them. The still color photographs will supplement their visual documentation for postflight engineering analysis and design verification. They will observe and photograph the RCS effects on the LM, the interactions of the surface and footpads, and the DPS effects on the surface as well as the general condition of all quadrants and landing struts.

### Early Apollo Scientific Experiments Package

When the crewmen reach the scientific equipment bay in Quad II, the LMP will open it and remove the Early Apollo Scientific Experiments Package (EASEP) using prerigged straps and pulleys as the CDR completes the LM inspection and photographically documents the LMP's activity. EASEP consists of two basic experiments: the Passive Seismic Experiment (PSE) and the Laser Ranging Retro-Reflector (LRRR). Both experiments are independent, self-contained packages weighing a total of about 170 pounds and occupying 12 cubic feet of space.

The PSE uses three long-period seismometers and one short-period vertical seismometer for measuring meteoroid impacts and moonquakes as well as to gather information on the moon's interior such as the existence of a core and mantle. The Passive Seismic Experiment Package (PSEP) has four basic subsystems: the structure/thermal subsystem provides shock, vibration, and thermal protection; the electrical power subsystem generates 34 to 46 watts by solar panel array; the data subsystem receives and decodes MSFN uplink commands and downlinks experiment data, handles power switching tasks; and the Passive Seismic Experiment subsystem measures lunar seismic activity with long-period and short-period seismometers which detect inertial mass displacement. Also included in this package are 15-watt radioisotope heaters to maintain the electronic package at a minimum of 60°F during the lunar night.

The LRRR experiment is a retro-reflector array with a folding support structure for aiming and aligning the array toward earth. The array is built of cubes of fused silica. Laser ranging beams from earth will be reflected back to their point of origin for precise measurement of earth-moon distances, center of moon's mass motion, lunar radius, earth geophysical information, and development of space communication technology.



Earth stations that will beam lasers to the LRRR include the McDonald Observatory at Fort Davis, Texas; the Lick Observatory in Mount Hamilton, California; and the Catalina Station of the University of Arizona. Scientists in other countries also plan to bounce laser beams off the LRRR.

In nominal deployment, as shown in Figures 24 through 26, the EASEP packages are removed individually from the storage receptacle and carried to the deployment site simultaneously. The crewmen will select a level site, nominally within  $\pm 15^\circ$  of the LM -Y axis and at least 70 feet from the LM. The selection of the site is based on a compromise between a site which minimizes the effects of the LM ascent engine during liftoff, heat and contamination by dust and insulation debris (kapton) from the LM Descent Stage, and a convenient site near the scientific equipment bay.

#### Documented Sample Collection

After the astronauts deploy the EASEP, they will select, describe as necessary, and collect lunar samples, as shown in Figure 27, until they terminate the EVA. The Documented Sample will provide a more detailed and selective variety of lunar material than will be obtained from the Contingency and Bulk Samples. It will include a core sample collected with a drive tube provided in the Sample Return Container, a gas analysis sample collected by placing a representative sample of the lunar surface material in a special gas analysis container, lunar geologic samples, and descriptive photographic coverage of lunar topographic features.

Samples will be collected using tools stored in the MESA and will be documented by photographs. Samples will be placed individually in prenumbered bags and the bags placed in the Sample Return Container.

#### Television and Photographic Coverage

The primary purpose of the TV is to provide a supplemental real-time data source to assure or enhance the scientific and operational data return. It may be an aid in determining the exact LM location on the lunar surface, in evaluating the EMU and man's capabilities in the lunar environment, and in documenting the sample collections. The TV will be useful in providing continuous observation for time correlation of crew activity with telemetered data, voice comments, and photographic coverage.

Photography consists of both still and sequence coverage using the Hasselblad camera, the Maurer data acquisition camera, and the Apollo Lunar Surface Close-Up Camera (ALSCC). The crewmen will use the Hasselblad extensively on the surface to document each major task which they accomplish. Additional photography, such as panoramas and scientific documentation, will supplement other data in the postflight analysis of the lunar environment and the astronauts'

6/24/69

Page 37

# EARLY APOLLO SCIENTIFIC EXPERIMENTS PACKAGE DEPLOYMENT

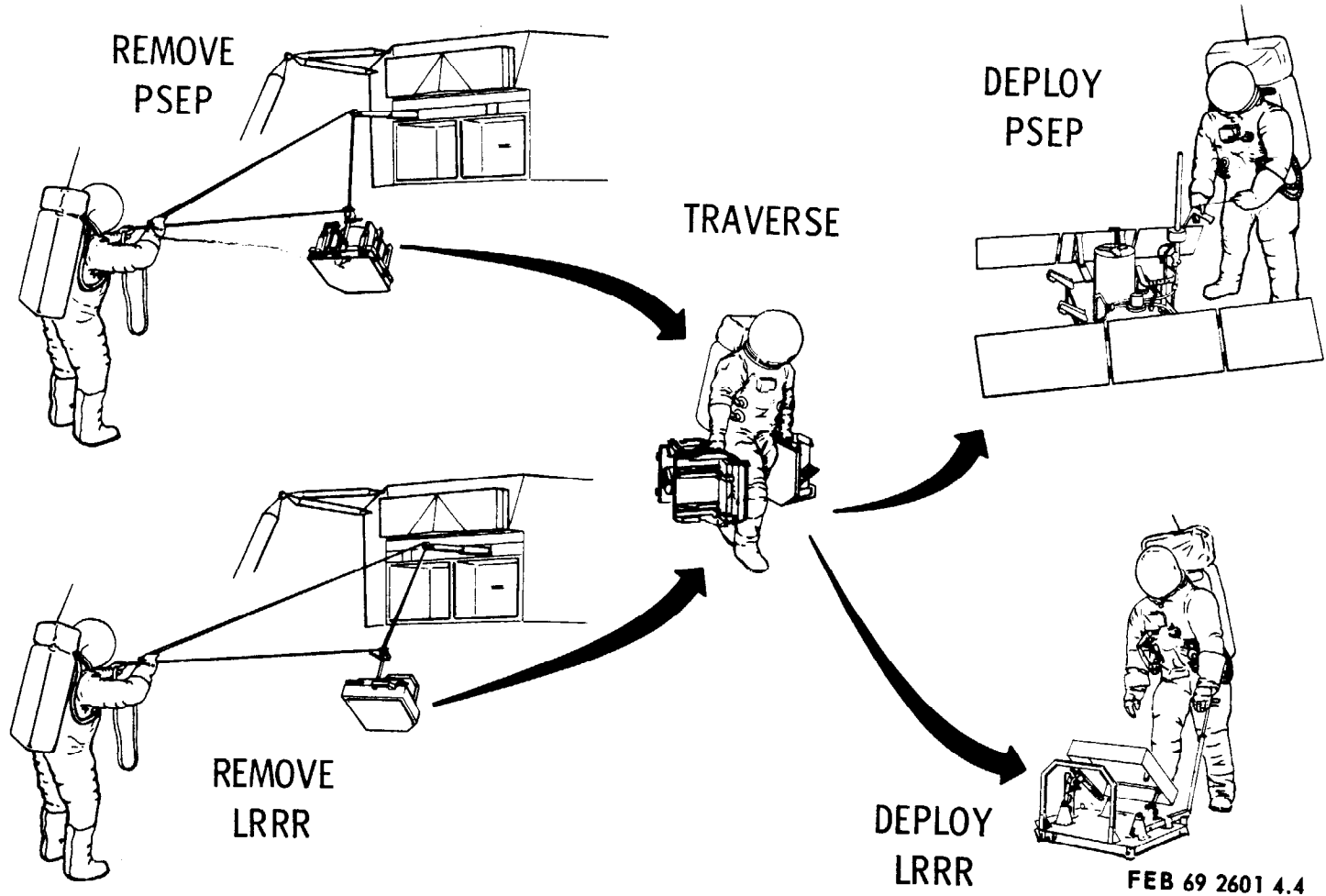

FEB 69 2601 4.4

PSEP- PASSIVE SEISMIC EXPERIMENTS PACKAGE  
LRRR- LASER RANGING RETRO REFLECTOR

Fig. 24

Fig. 25

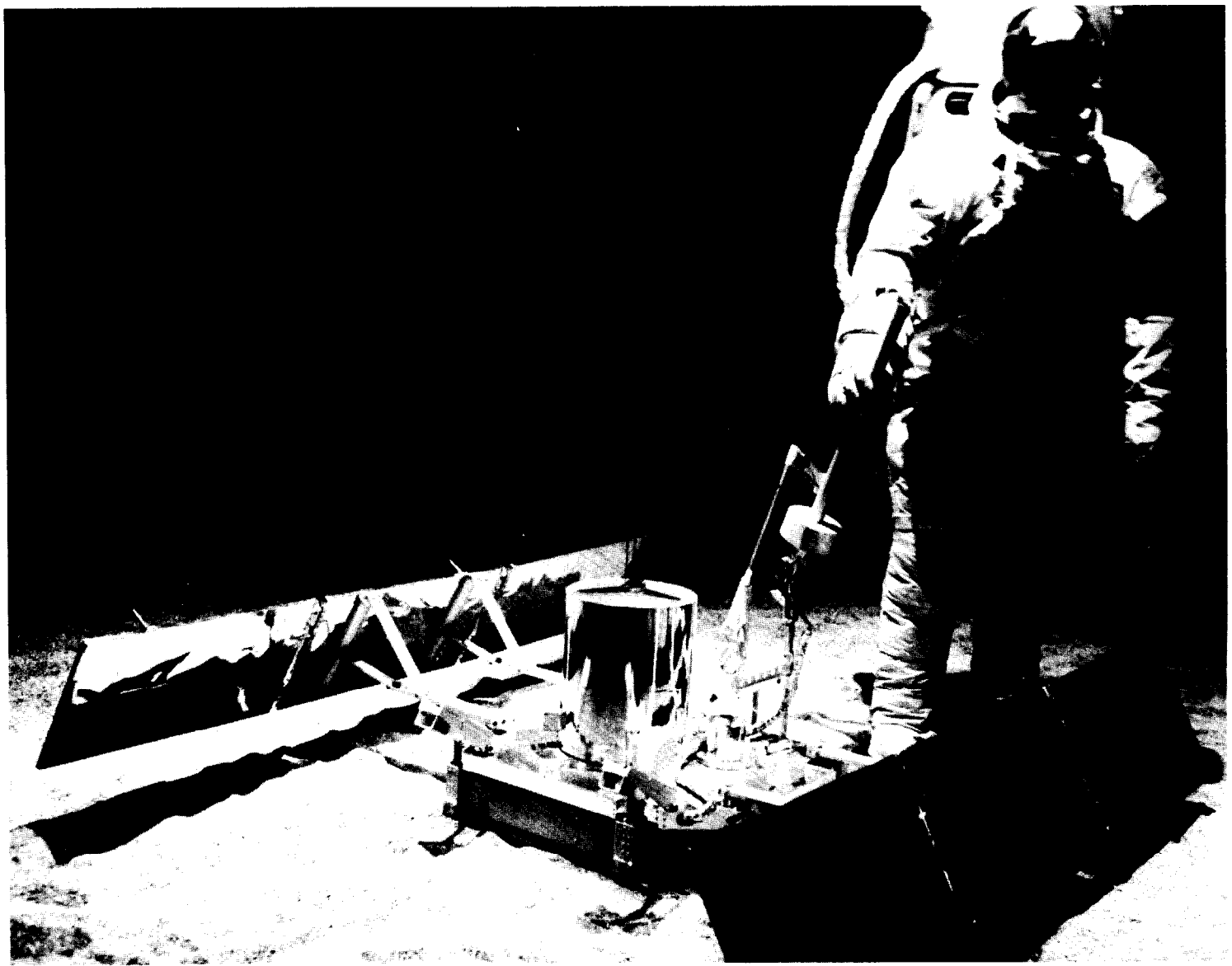

DEPLOYED PASSIVE SEISMIC EXPERIMENT

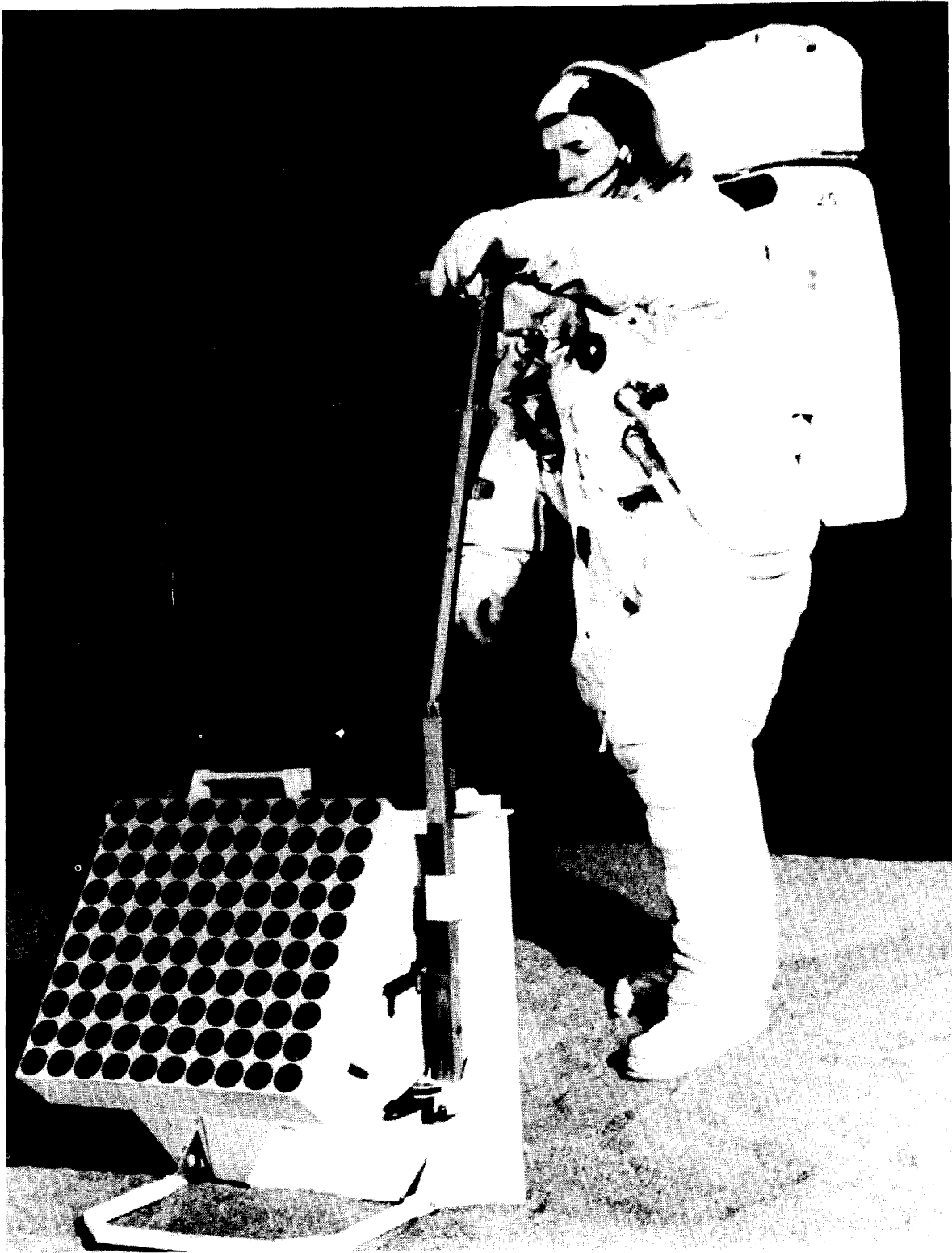

DEPLOYED LASER RANGING RETRO-REFLECTOR

Fig. 26

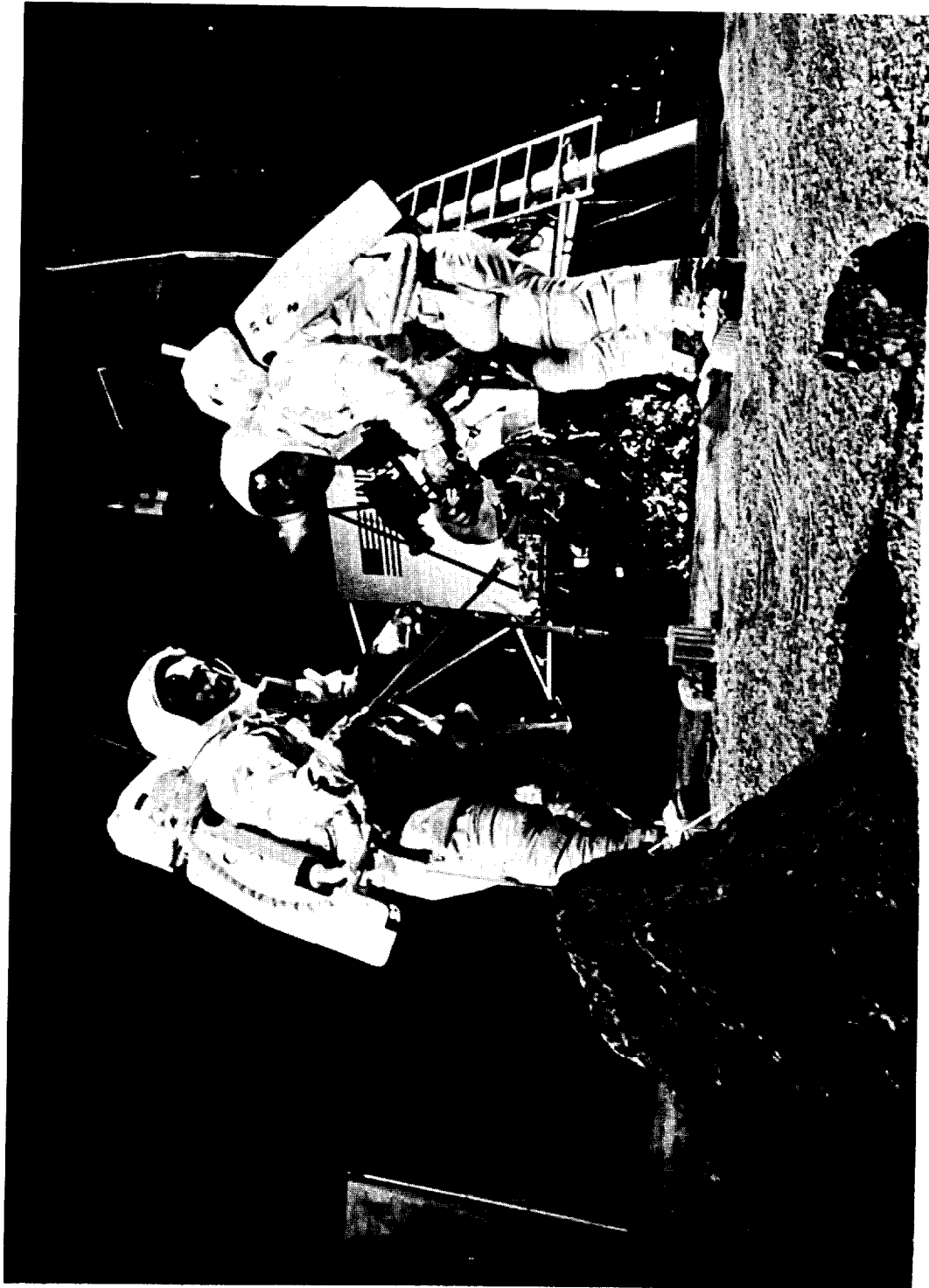

DOCUMENTED SAMPLE COLLECTION

Fig. 27

capabilities or limitations in conducting lunar surface operations. The ALSCC is a stereo camera and will be used for recording the fine textural details of the lunar surface material. The data acquisition camera (sequence camera) view from the LM Ascent Stage window will provide almost continuous coverage of the surface activity. The LMP, who remains inside the Ascent Stage for the first few minutes of the EVA, will use the sequence camera to document the CDR's initial surface activities. Then, before he egresses, the LMP will position the camera for optimum surface coverage while both crewmen are on the surface. After the first crewman (LMP) ingresses he can use the sequence camera to provide coverage of the remaining surface activity.

### Extravehicular Activity Termination

The LMP will ingress before the SRC's are transferred to the LM. He will assist during the SRC transfer and will also make a LM systems check, change the sequence camera film magazine, and reposition the camera to cover the SRC transfer and the CDR's ladder ascent.

As each man begins his EVA termination he will clean the EMU. Although the crew will have a very limited capability to remove lunar material from their EMU's they will attempt to brush off any dust or particles from the portions of the suit which they can reach and from the boots on the footpad and ladder.

In the EVA termination there are two tasks that will require some increased effort. The first is the ascent from the footpad to the lowest ladder rung. In the unstroked position the vertical distance from the top of the footpad to the lowest ladder rung is 31 inches. In a nominal level landing this distance will be decreased only about 4 inches. Thus, unless the strut is stroked significantly the crewman is required to spring up using his legs and arms to best advantage to reach the bottom rung of the ladder from the footpad.

The second task will be the ingress or the crewmen's movement through the hatch opening to a standing position inside the LM. The hatch opening and the space inside the LM are small. Therefore, the crewmen must move slowly to prevent possible damage to their EMU's or to the exposed LM equipment.

After the crewmen enter the LM, they will jettison the equipment they no longer need. The items to be jettisoned are the used ECS canister and bracket, OPS brackets (adapters), and three armrests. The crewmen will then close the hatch and pressurize the LM. The EVA is considered to be terminated after the crewmen start this initial cabin pressurization. After the cabin pressure has stabilized, the crewmen will doff their PLSS's, connect to the LM ECS, and prepare to jettison more equipment they no longer need. The equipment, such as the PLSS's, lunar boots, and cameras, will be stowed in two containers. The LM will again be depressurized, the hatch opened, the containers jettisoned, and the cabin repressurized. Table 4 shows the loose equipment left on the lunar surface.

## TABLE 4

LOOSE EQUIPMENT LEFT ON LUNAR SURFACEDuring EVA

TV equipment  
     camera  
     tripod  
     handle/cable assembly  
     MESA bracket  
 Solar Wind Composition staff  
 Apollo Lunar Handtools -  
     scoop  
     tongs  
     extension handle  
     hammer  
     gnomon  
 Equipment stowed in Sample Return Containers (outbound) -  
     extra York mesh packing material  
     SWC bag (extra)  
     spring scale  
     unused small sample bags  
     two core tube bits  
     two SRC seal protectors  
     environmental sample containers O rings  
  
 Apollo Lunar Surface Close-up Camera (film cassette returned)  
 Hasselblad EL Data Camera (magazine returned)

EVA termination

Lunar equipment conveyor  
 ECS canister and bracket  
 OPS brackets  
 Three armrests

Post-EVA equipment jettison

Two Portable Life Support Systems  
 Left hand side stowage compartment (with equipment - such as  
     lunar boots - inside)  
 One armrest

Following the EVA and post-EVA activities, there will be another rest period of 4 hours 40 minutes duration, prior to preparation for liftoff.

#### Command/Service Module Plane Change

The CSM will perform a plane change of  $0.18^\circ$  approximately 2.25 revolutions after LM touchdown. This maneuver will permit a nominally coplanar rendezvous by the LM.

#### Lunar Module Ascent to Docking

After completion of crew rest and ascent preparations, the LM Ascent Propulsion System (APS) and the LM RCS will be used for powered ascent, rendezvous, and docking with the CSM.

Powered ascent will be performed in two phases during a single continuous burn of the ascent engine. The first phase will be a vertical rise, as shown in Figure 28, required for the Ascent Stage to clear the lunar terrain. The second will be an orbital insertion maneuver which will place the LM in an orbit approximately  $9 \times 45$  NM. Figure 29 shows the LM ascent through orbit insertion. Figure 30 shows the complete rendezvous maneuver sequence and the coverage capability of the rendezvous radar (RR) and the MSFN tracking. After insertion into orbit, the LM will compute and execute the coelliptic rendezvous sequence which nominally consists of four major maneuvers: concentric sequence initiation (CSI), constant delta height (CDH), terminal phase initiation (TPI), and terminal phase finalization (TPF). The CSI maneuver will be performed to establish the proper phasing conditions at CDH so that, after CDH is performed, TPI will occur at the desired time and elevation angle. CSI will nominally circularize the LM orbit 15 NM below that of the CSM. CSI is a posigrade maneuver that is scheduled to occur approximately at apolune. CDH nominally would be a small radial burn to make the LM orbit coelliptic with the orbit of the CSM. The CDH maneuver would be zero if both the CSM and LM orbits are perfectly circular at the time of CDH. The LM will maintain RR track attitude after CDH and continue to track the CSM. Meanwhile the CSM will maintain sextant/VHF ranging tracking of the LM. The TPI maneuver will be performed with the LM RCS thrusters approximately 38 minutes after CDH. Two midcourse corrections (MCC-1 and MCC-2) are scheduled between TPI and TPF, but are nominally zero. TPF braking will begin approximately 42 minutes after TPI and end with docking to complete approximately 3.5 hours of rendezvous activities. One lunar revolution, recently added to the flight plan, will allow LM housekeeping activities primarily associated with back contamination control procedures. Afterward, the LM crewmen will transfer to the CSM with the lunar samples and exposed film.



### LUNAR MODULE VERTICAL RISE PHASE

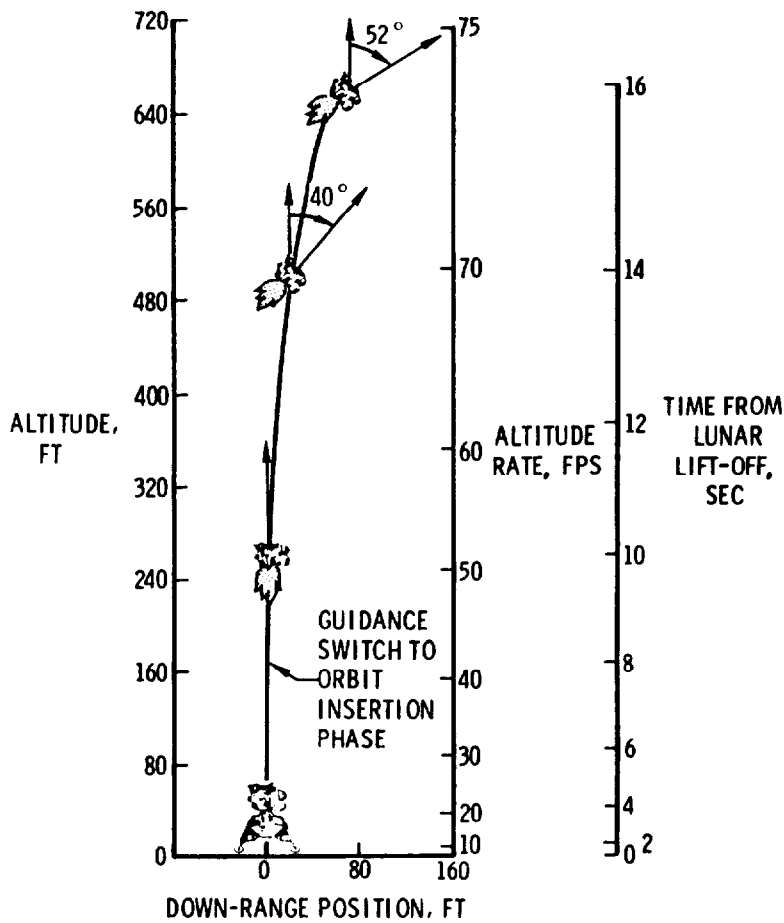
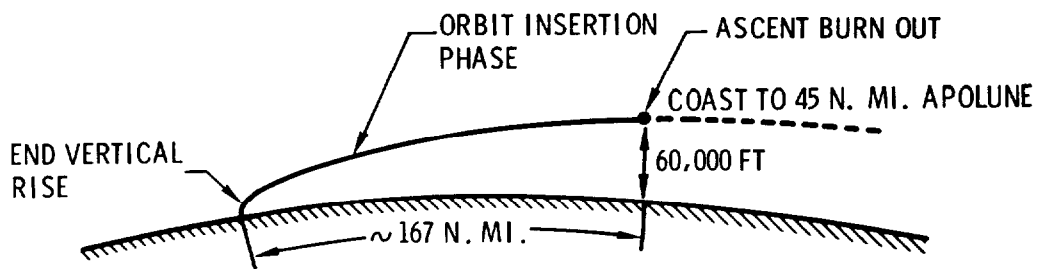

Fig. 28

### ORBIT INSERTION PHASE



TOTAL ASCENT:  
 BURN TIME = 7:15 MIN:SEC  
 $\Delta V$  REQUIRED = 6,056 FPS  
 PROPELLANT REQUIRED = 4,980 LBS

Fig. 29

## RENDEZVOUS MANEUVERS/RADAR COVERAGE

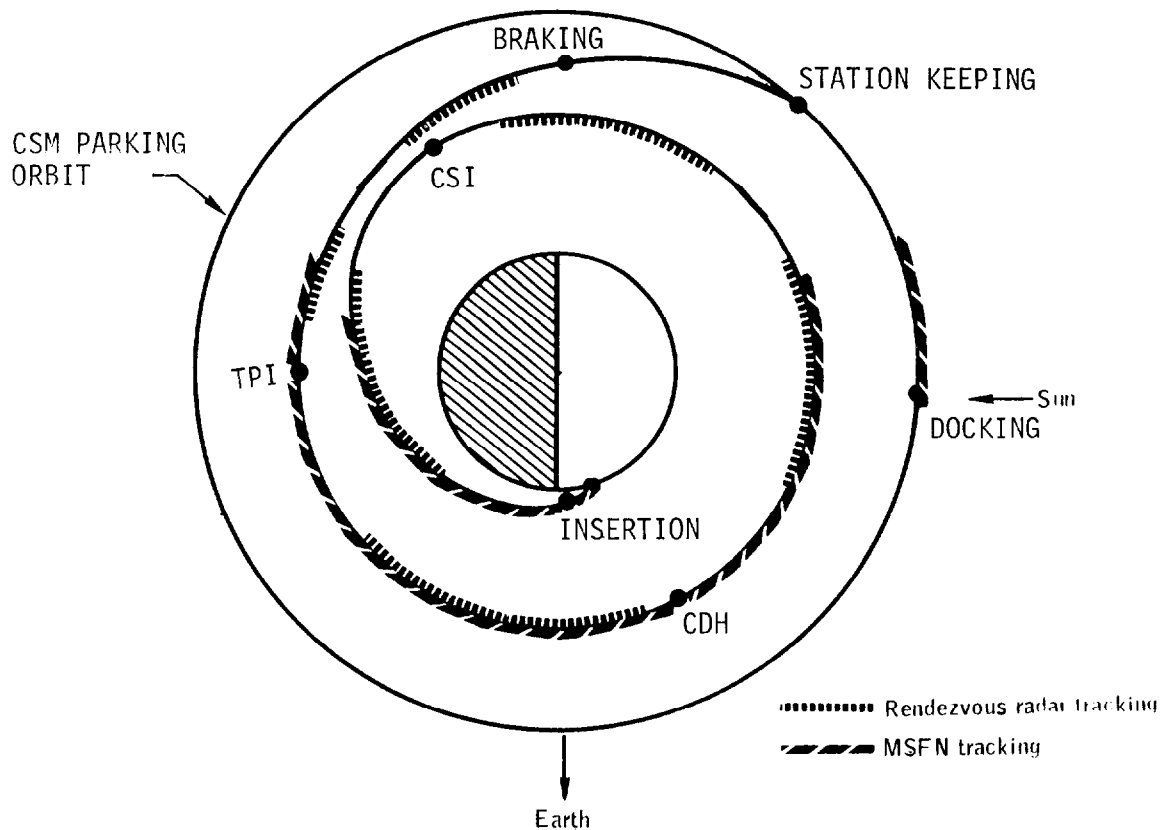

Fig. 30

Lunar Module Jettison to Transearth Injection

Approximately 2 hours after hard docking, the CSM will jettison the LM and then separate from the LM by performing a 1-fps RCS maneuver. The crew will then eat, photograph targets of opportunity, and prepare for transearth injection (TEI). Figure 31 presents a summary of activities from lunar orbit insertion through transearth injection.

Transearth Injection

The burn will occur 59.5 hours after LOI-1 as the CSM crosses the antipode on the far side of the moon. The spacecraft configuration for transearth injection and transearth coast is shown in Figure 32.

# LUNAR ACTIVITIES SUMMARY

6/24/69

Page 46

Fig. 31

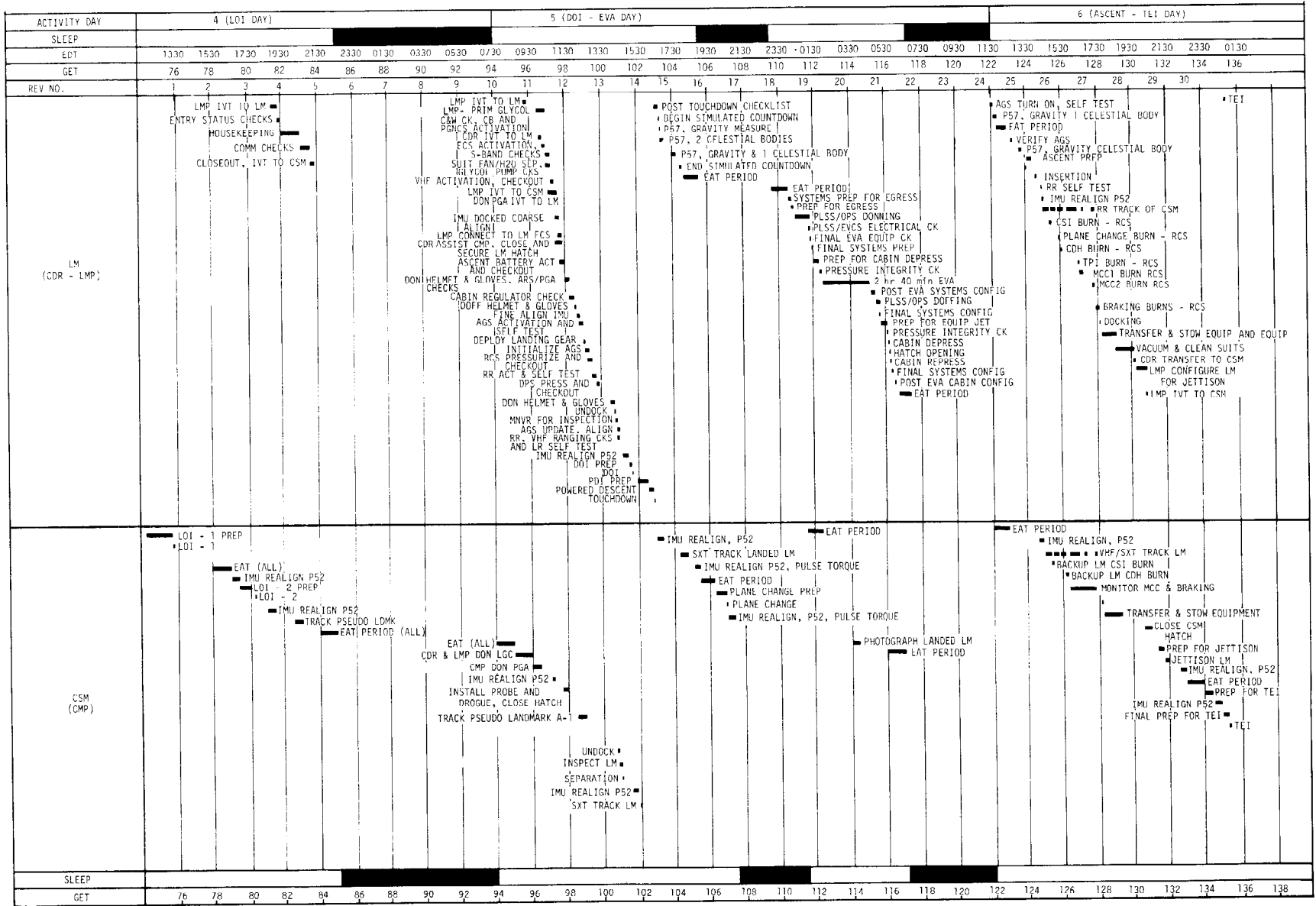

M-932-69-11

### Transearth Coast

During transearth coast, three midcourse correction (MCC) decision points have been defined, as shown in Figure 33. The maneuvers will be targeted for corridor control only and will be made at the following times if required:

- MCC-5 - TEI plus 15 hours
- MCC-6 - Entry interface (EI) minus 15 hours
- MCC-7 - EI minus 3 hours.

### TRANSEARTH CONFIGURATION

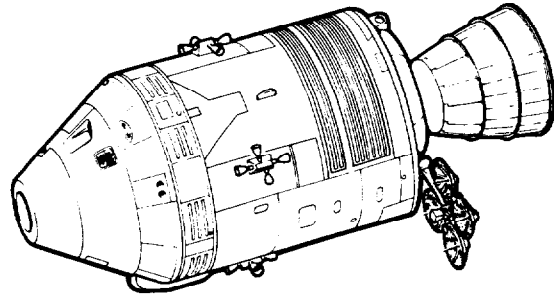

Fig. 32

These corrections will utilize the MSFN for navigation. In the transearth phase there will be continuous communications coverage from the time the spacecraft appears from behind the moon until about 1 minute prior to entry. The constraints influencing the spacecraft attitude timeline are thermal control, communications, crew rest cycle, and preferred times of MCC's. The attitude profile for the transearth phase is complicated by more severe fuel slosh problems than for the other phases of the mission.

### Entry Through Landing

Prior to atmospheric entry, the final MCC will be made and the CM will be separated from the SM using the SM RCS. The spacecraft will reach entry interface (EI) at 400,000 feet, as shown in Figure 34, with a velocity of 36,194 fps. The S-band communication blackout will begin 18 seconds later followed by C-band communication blackout 28 seconds from EI. The rate of heating will reach a maximum 1 minute 10 seconds after EI. The spacecraft will exit from C-band blackout 3 minutes 4 seconds after entry and from S-band blackout 3 minutes 30 seconds after entry. Drogue parachute deployment will occur 8 minutes 19 seconds after entry at an altitude of 23,000 feet, followed by main parachute deployment at EI plus 9 minutes 7 seconds. Landing will occur approximately 14 minutes 2 seconds after and 1285 NM downrange from EI.

Landing will be in the Pacific Ocean at 172°W longitude, 11°N latitude and will occur approximately 8 days 3 hours after launch.

### TRANSEARTH PHASE

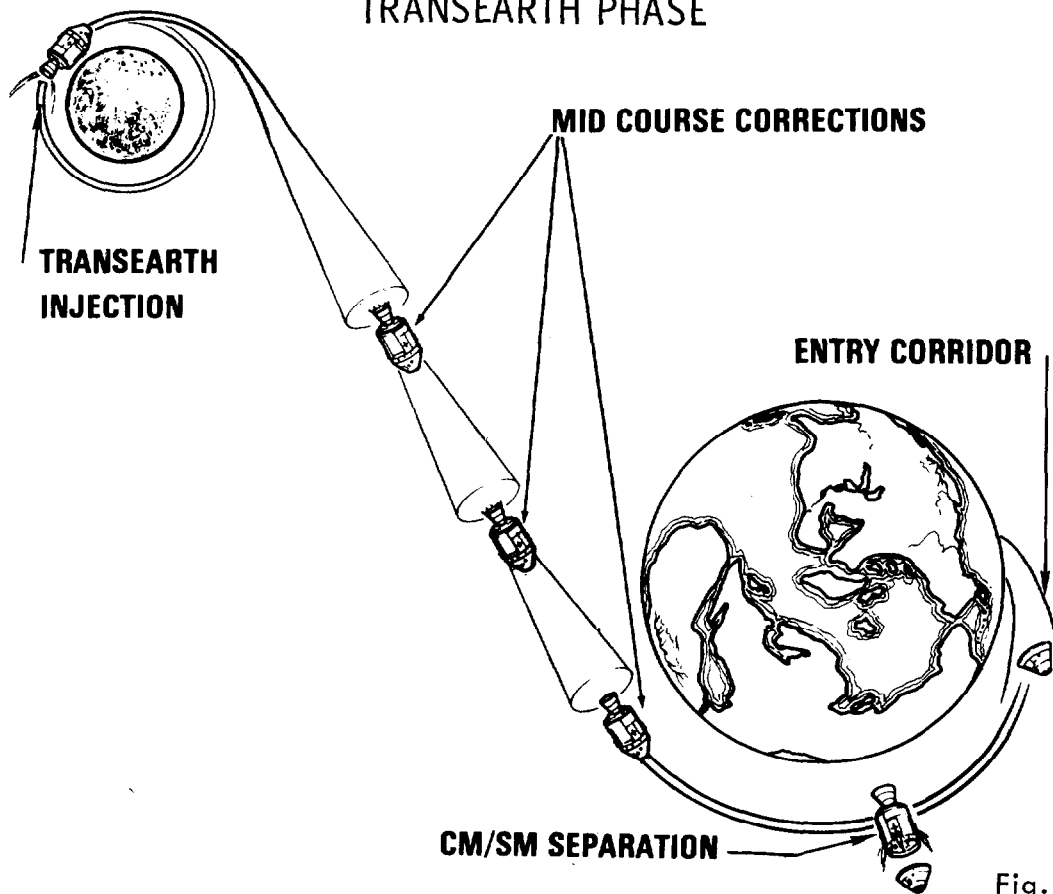

Fig. 33

### ENTRY & DESCENT TO EARTH

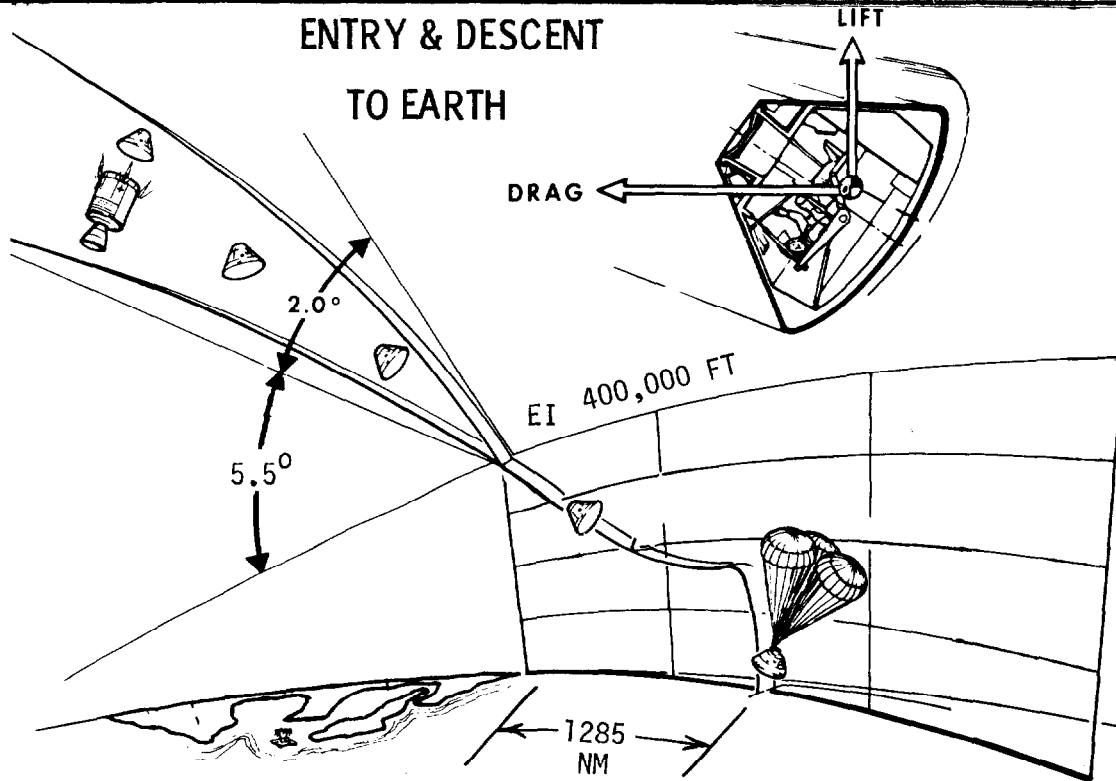

Fig. 34

### Postlanding Operations

Following landing, the recovery helicopter will drop swimmers who will install the flotation collar to the CM. A large, 7-man liferaft will be deployed and attached to the flotation collar. Biological Isolation Garments (BIG's) will be lowered into the raft, and one swimmer will don a BIG while the astronauts don BIG's inside the CM. Two other swimmers will move upwind of the CM on a second large raft. The post-landing ventilation fan will be turned off, the CM will be powered down, and the astronauts will egress to the raft. The swimmer will then decontaminate all garments, the hatch area, and the collar.

The helicopter will recover the astronauts and the recovery physician riding in the helicopter will provide any required assistance. After landing on the recovery carrier, the helicopter will be towed to the hanger deck. The astronauts and the physician will then enter the Mobile Quarantine Facility (MQF). The flight crew, recovery physician and recovery technician will remain inside the MQF until it is delivered to the Lunar Receiving Laboratory (LRL) at the Manned Spacecraft Center (MSC) in Houston, Texas.

After flight crew pickup by the helicopter, the auxiliary recovery loop will be attached to the CM. The CM will be retrieved and placed in a dolly aboard the recovery ship. It will then be moved to the MQF and mated to the Transfer Tunnel. From inside the MQF/CM containment envelope, the MQF engineer will begin post-retrieval procedures (removal of lunar samples, data, equipment, etc.), passing the removed items through the decontamination lock. The CM will remain sealed during RCS deactivation and delivery to the LRL. The SRC, film, data, etc. will be flown to the nearest airport from the recovery ship for transport to MSC. The MQF and spacecraft will be off-loaded from the ship at Pearl Harbor and then transported by air to the LRL.

In order to minimize the risk of contamination of the earth's biosphere by lunar material, quarantine measures will be enforced. The crew will be quarantined for approximately 21 days after liftoff from the lunar surface. In addition, the CM will be quarantined after landing. Termination of the CM quarantine period will be dependent on the results of the lunar sample analysis and observations of the crew.

## BACK CONTAMINATION PROGRAM

The Apollo Back Contamination Program can be divided into three phases, as shown in Figure 35. The first phase covers the procedures which are followed by the crew while in flight to minimize the return of lunar surface contaminants in the Command Module.

The second phase includes spacecraft and crew recovery and the provisions for isolation and transport of the crew, spacecraft, and lunar samples to the Manned Spacecraft Center. The third phase encompasses the quarantine operations and preliminary sample analysis in the Lunar Receiving Laboratory (LRL).

A primary step in preventing back contamination is careful attention to spacecraft cleanliness following lunar surface operations. This includes use of special cleaning equipment, stowage provisions for lunar-exposed equipment, and crew procedures for proper "housekeeping."

## LUNAR MODULE OPERATIONS

The Lunar Module (LM) has been designed with a bacterial filter system to prevent contamination of the lunar surface when the cabin atmosphere is released at the start of lunar exploration. Prior to reentering the LM after lunar surface exploration, the crewmen will brush any lunar surface dust or dirt from the space suit using the suit gloves. They will scrape their overboots on the LM footpad and while ascending the LM ladder dislodge any clinging particles by a kicking action. After entering the LM and pressurizing the cabin, the crew will doff their Portable Life Support System, Oxygen Purge System, lunar boots, EVA gloves, etc. The equipment to be jettisoned will be assembled and bagged to be subsequently left on the lunar surface. The lunar boots, likely the most contaminated items, will be placed in a bag as early as possible to minimize the spread of lunar particles. Following LM rendezvous and docking with the Command Module (CM), the CM tunnel will be pressurized and checks made to insure that an adequate pressurized seal has been made. During this period, the LM, space suits, and lunar surface equipment will be vacuumed. To accomplish this, one additional lunar orbit has been added to the mission.

The LM cabin atmosphere will be circulated through the Environmental Control System (ECS) suit circuit lithium hydroxide canister to filter particles from the atmosphere. A minimum of 5 hours of weightless operation and filtering will reduce the original airborne contamination to about  $10^{-15}$  percent.

To prevent dust particles from being transferred from the LM atmosphere to the CM, a constant flow of 0.8 lb/hr oxygen will be initiated in the CM at the start of combined LM/CM operation. Oxygen will flow from the CM into the LM then overboard through the LM cabin relief valve or through spacecraft leakage. Since the flow of gas is always from the CM to the LM, diffusion and flow of dust contamination into the CM will be minimized. After this positive gas flow has been established from the CM, the tunnel hatch will be removed.

# APOLLO BACK CONTAMINATION PROGRAM

6/24/69

PHASE I  
SPACECRAFT  
OPERATIONS

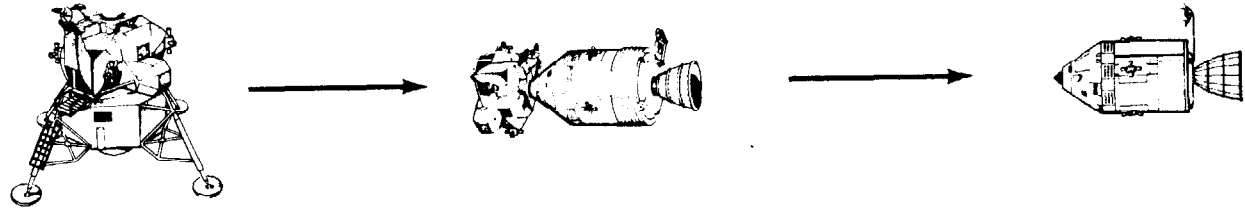

PHASE II  
RECOVERY



PHASE III  
LRL

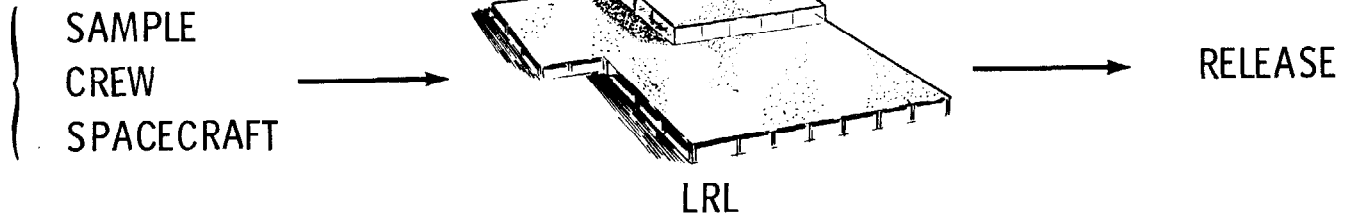

Page 51

Fig. 35

M-932-69-11