

80-27

**P
R
E
S
S

K
I
T**

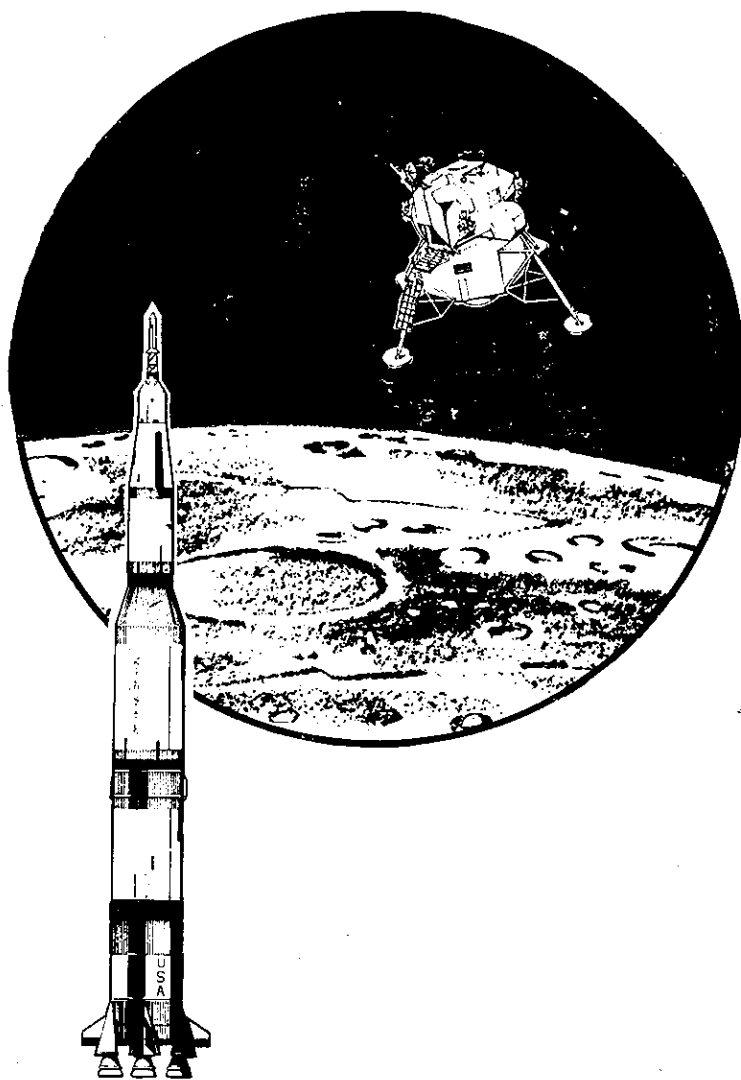

**APOLLO 11
LUNAR LANDING MISSION**



NATIONAL AERONAUTICS AND SPACE ADMINISTRATION

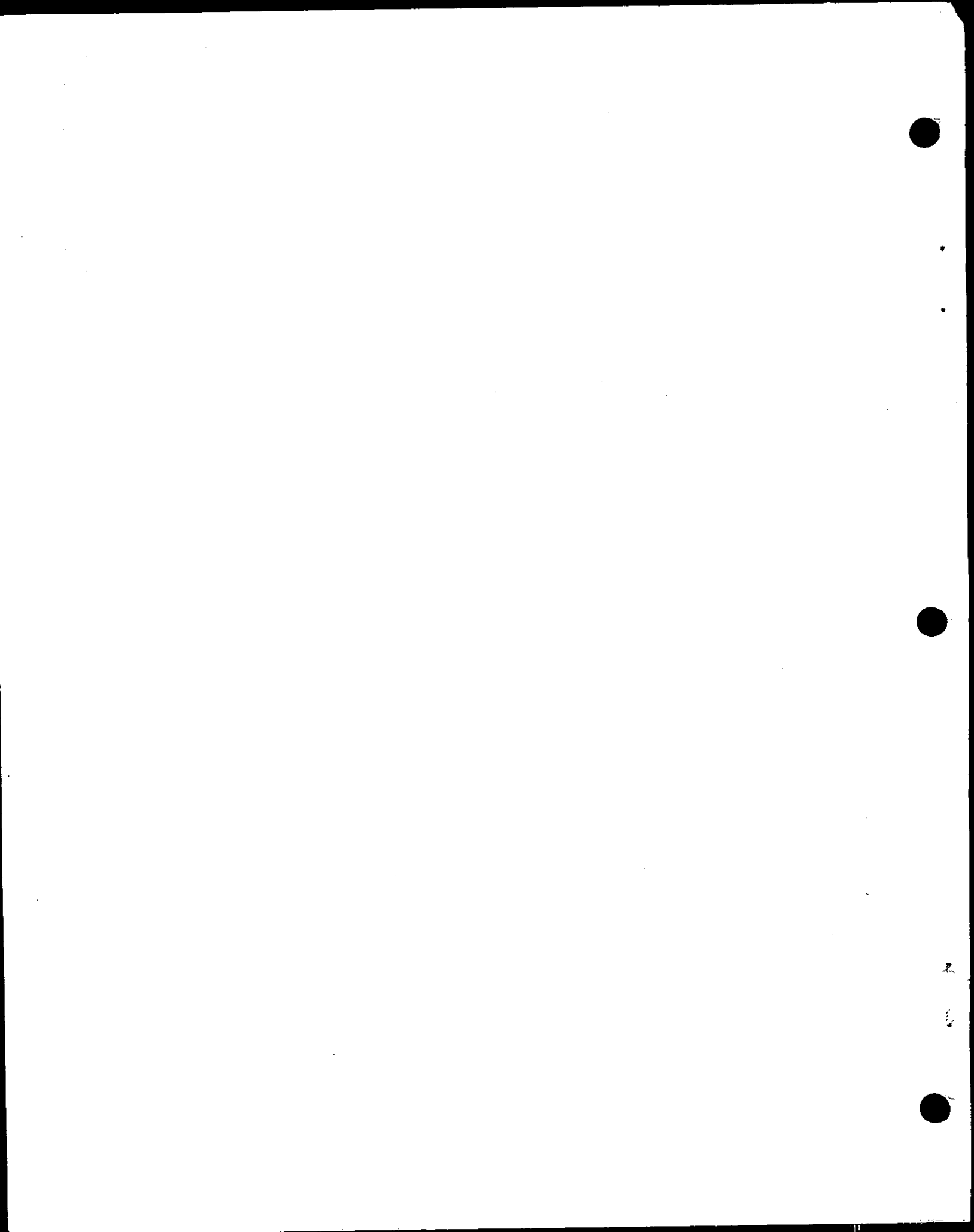



FOR RELEASE: SUNDAY
July 6, 1969

RELEASE NO: 69-83K

PROJECT: APOLLO 11
(To be launched no
earlier than July 16)

contents

GENERAL RELEASE-----	1-17
APOLLO 11 COUNTDOWN-----	18-20
LAUNCH EVENTS-----	21
APOLLO 11 MISSION EVENTS-----	22-25
MISSION TRAJECTORY AND MANEUVER DESCRIPTION-----	26
Launch-----	26-30
Earth Parking Orbit (EPO)-----	30
Translunar Injection (TLI)-----	30
Transposition, Docking and Ejection (TD&E)-----	30-32
Translunar Coast-----	33
Lunar Orbit Insertion (LOI)-----	33
Lunar Module Descent, Lunar Landing-----	33-41
Lunar Surface Extravehicular Activity (EVA)-----	42-47
Lunar Sample Collection-----	48
LM Ascent, Lunar Orbit Rendezvous-----	49-53
Transearth Injection (TEI)-----	53-56
Transearth Coast-----	57
Entry Landing-----	57-63
RECOVERY OPERATIONS, QUARANTINE-----	64-65
Lunar Receiving Laboratory-----	65-67
SCHEDULE FOR TRANSPORT OF SAMPLES, SPACECRAFT & CREW-----	68
LUNAR RECEIVING LABORATORY PROCEDURES TIMELINE (TENTATIVE)-----	69-70
APOLLO 11 GO/NO-GO DECISION POINTS-----	71
APOLLO 11 ALTERNATE MISSIONS-----	72-73
ABORT MODES-----	74
Deep Space Aborts-----	74-76
ONBOARD TELEVISION-----	77
Tentative Apollo 11 TV Times-----	78
PHOTOGRAPHIC TASKS-----	79-80
LUNAR DESCRIPTION-----	81
Physical Facts-----	81
Apollo Lunar Landing Sites-----	82-85

COMMAND AND SERVICE MODULE STRUCTURE, SYSTEMS-----	86-88
CSM Systems-----	88-95
LUNAR MODULE STRUCTURES, WEIGHT-----	96
Ascent Stage-----	96-101
Descent Stage-----	101-103
Lunar Module Systems-----	103-107
SATURN V LAUNCH VEHICLE DESCRIPTION & OPERATION-----	108
Launch Vehicle Range Safety Provisions-----	108-109
Space Vehicle Weight Summary-----	110-111
First Stage-----	112
Second Stage-----	112-113
Third Stage-----	113
Instrument Unit-----	113-114
Propulsion-----	114-115
Launch Vehicle Instrumentation and Communication-----	115
S-IVB Restart-----	116
Differences in Launch Vehicles for A-10 and A-11-----	116
APOLLO 11 CREW-----	117
Life Support Equipment - Space Suits-----	117-122
Apollo 11 Crew Menu-----	123-132
Personal Hygiene-----	133
Medical Kit-----	133
Survival Gear-----	133-135
Biomedical Inflight Monitoring-----	135
Training-----	136-137
Crew Biographies-----	138-144
EARLY APOLLO SCIENTIFIC EXPERIMENTS PACKAGE-----	145-153
APOLLO LUNAR RADIOISOTOPIC HEATER (ALRH)-----	154-157
APOLLO LAUNCH OPERATIONS-----	158
Prelaunch Preparations-----	158-160
LAUNCH COMPLEX 39-----	161
Vehicle Assembly Building-----	162-163
Launch Control Center-----	163-164
Mobile Launcher-----	164-165
Transporter-----	165-166
Crawlerway-----	166
Mobile Service Structure-----	166-167
Water Deluge System-----	167
Flame Trench and Deflector-----	167-168
Pad Areas-----	168
Mission Control Center-----	169-170
MANNED SPACE FLIGHT NETWORK-----	171-174
NASA Communications Network-----	174-176
Network Computers-----	176-177
The Apollo Ships-----	178
Apollo Range Instrumentation Aircraft (ARIA)-----	179
Ship Positions for Apollo 11-----	180

CONTAMINATION CONTROL PROGRAM-----	181
Lunar Module Operations-----	181-187
Command Module Operations-----	187
Lunar Mission Recovery Operations-----	187-188
Biological Isolation Garment-----	188
Mobile Quarantine Facility-----	188
Lunar Receiving Laboratory-----	189-190
Sterilization and Release of Spacecraft-----	190-191
APOLLO PROGRAM MANAGEMENT-----	192
Apollo/Saturn Officials-----	193-217
Major Apollo/Saturn V Contractors-----	218-219
PRINCIPAL INVESTIGATORS AND INVESTIGATIONS OF	
LUNAR SURFACE SAMPLES-----	220-241
APOLLO GLOSSARY-----	242-246
APOLLO ACRONYMS AND ABBREVIATIONS-----	247-248
CONVERSION FACTORS-----	249-250



NEWS



NATIONAL AERONAUTICS AND SPACE ADMINISTRATION
WASHINGTON, D.C. 20546

TELS. WO 2-4155
WO 3-6925

FOR RELEASE: SUNDAY
July 6, 1969

RELEASE NO: 69-83K

APOLLO 11

The United States will launch a three-man spacecraft toward the Moon on July 16 with the goal of landing two astronaut-explorers on the lunar surface four days later.

If the mission--called Apollo 11--is successful, man will accomplish his long-time dream of walking on another celestial body.

The first astronaut on the Moon's surface will be 38-year-old Neil A. Armstrong of Wapakoneta, Ohio, and his initial act will be to unveil a plaque whose message symbolizes the nature of the journey.

Affixed to the leg of the lunar landing vehicle, the plaque is signed by President Nixon, Armstrong and his Apollo 11 companions, Michael Collins and Edwin E. Aldrin, Jr.

-more-

6/26/69

It bears a map of the Earth and this inscription:

HERE MEN FROM THE PLANET EARTH

FIRST SET FOOT UPON THE MOON.

JULY 1969 A.D.

WE CAME IN PEACE FOR ALL MANKIND

The plaque is fastened to the descent stage of the lunar module and thus becomes a permanent artifact on the lunar surface.

Later Armstrong and Aldrin will emplant an American flag on the surface of the Moon.

The Apollo 11 crew will also carry to the Moon and return two large American flags, flags of the 50 states, District of Columbia and U.S. Territories, flags of other nations and that of the United Nations Organization.

During their 22-hour stay on the lunar surface, Armstrong and Aldrin will spend up to 2 hours and 40 minutes outside the lunar module, also gathering samples of lunar surface material and deploying scientific experiments which will transmit back to Earth valuable data on the lunar environment.

Apollo 11 is scheduled for launch at 9:32 a.m. EDT July 16 from the National Aeronautics and Space Administration's Kennedy Space Center Launch Complex 39-A. The mission will be the fifth manned Apollo flight and the third to the Moon.

The prime mission objective of Apollo 11 is stated simply: "Perform a manned lunar landing and return". Successful fulfillment of this objective will meet a national goal of this decade, as set by President Kennedy May 25, 1961.

Apollo 11 Commander Armstrong and Command Module Pilot Collins 38, and Lunar Module Pilot Aldrin, 39, will each be making his second space flight. Armstrong was Gemini 8 commander, and backup Apollo 8 commander; Collins was Gemini 10 pilot and was command module pilot on the Apollo 8 crew until spinal surgery forced him to leave the crew for recuperation; and Aldrin was Gemini 12 pilot and Apollo 8 backup lunar module pilot. Armstrong is a civilian, Collins a USAF lieutenant colonel and Aldrin a USAF colonel.

Apollo 11 backup crewmen are Commander James A. Lovell, Command Module Pilot William A. Anders, both of whom were on the Apollo 8 first lunar orbit mission crew, and Lunar Module Pilot Fred W. Haise.

The backup crew functions in three significant categories. They help the prime crew with mission preparation and hardware checkout activities. They receive nearly complete mission training which becomes a valuable foundation for later assignment as a prime crew and finally, should the prime crew become unavailable, they are prepared to fly as prime crew on schedule up until the last few weeks at which time full duplicate training becomes too costly and time consuming to be practical.

Apollo 11, after launch from Launch Complex 39-A, will begin the three-day voyage to the Moon about two and a half hours after the spacecraft is inserted into a 100-nautical mile circular Earth parking orbit. The Saturn V launch vehicle third stage will restart to inject Apollo 11 into a translunar trajectory as the vehicle passes over the Pacific midway through the second Earth parking orbit.

The "go" for translunar injection will follow a complete check-out of the space vehicle's readiness to be committed for injection. About a half hour after translunar injection (TLI), the command/service module will separate from the Saturn third stage, turn around and dock with the lunar module nested in the spacecraft LM adapter. Spring-loaded lunar module hold-downs will be released to eject the docked spacecraft from the adapter.

APOLLO 11 — Launch And Translunar Injection

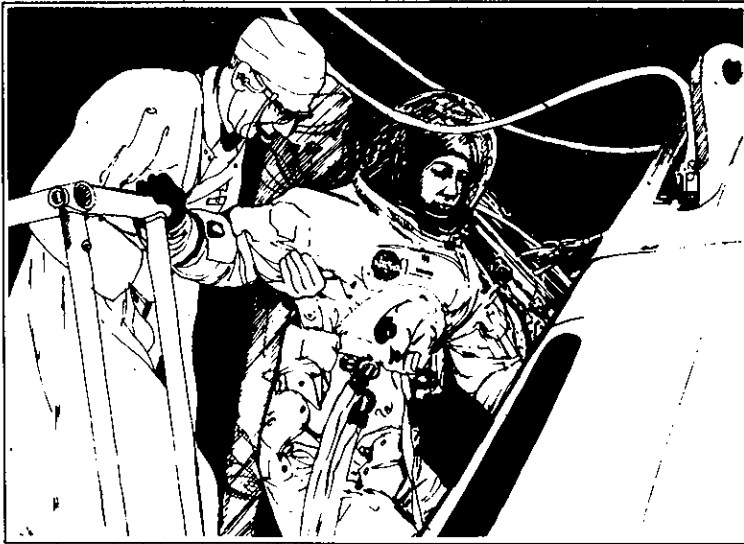

Astronaut Insertion



Check Of Systems

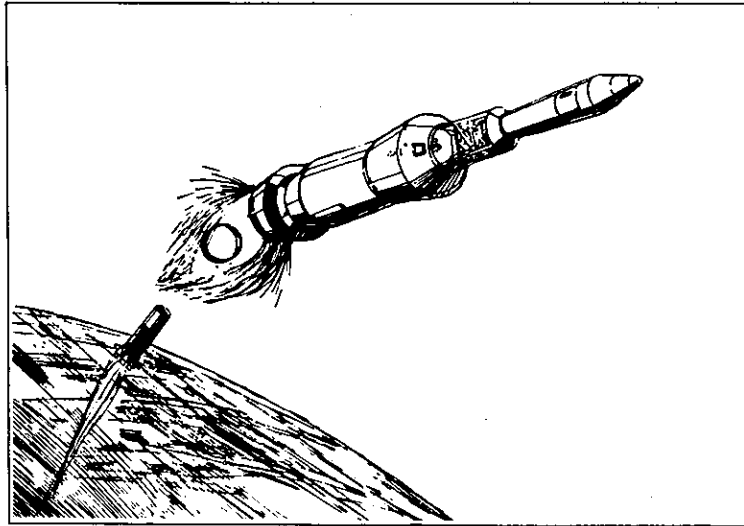

Saturn Staging

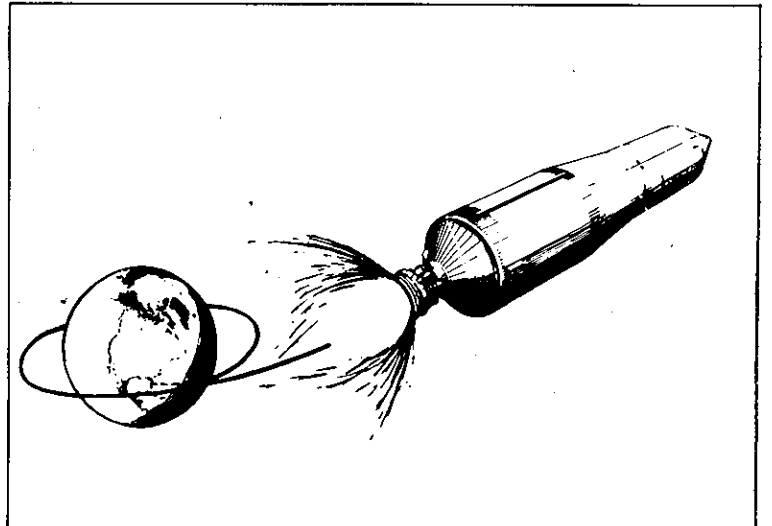

Translunar Injection

-more-

-5-

Later, leftover liquid propellant in the Saturn third stage will be vented through the engine bell to place the stage into a "slingshot" trajectory to miss the Moon and go into solar orbit.

During the translunar coast, Apollo 11 will be in the passive thermal control mode in which the spacecraft rotates slowly about one of its axes to stabilize thermal response to solar heating. Four midcourse correction maneuvers are possible during translunar coast and will be planned in real time to adjust the trajectory.

Apollo 11 will first be inserted into a 60-by-170-nautical mile elliptical lunar orbit, which two revolutions later will be adjusted to a near-circular 54 x 66 nm. Both lunar orbit insertion burns (LOI), using the spacecraft's 20,500-pound-thrust service propulsion system, will be made when Apollo 11 is behind the Moon and out of "sight" of Manned Space Flight Network stations.

Some 21 hours after entering lunar orbit, Armstrong and Aldrin will man and check out the lunar module for the descent to the surface. The LM descent propulsion system will place the LM in an elliptical orbit with a pericyynthion, or low point above the Moon, of 50,000 feet, from which the actual descent and touchdown will be made.

APOLLO 11 — Translunar Flight

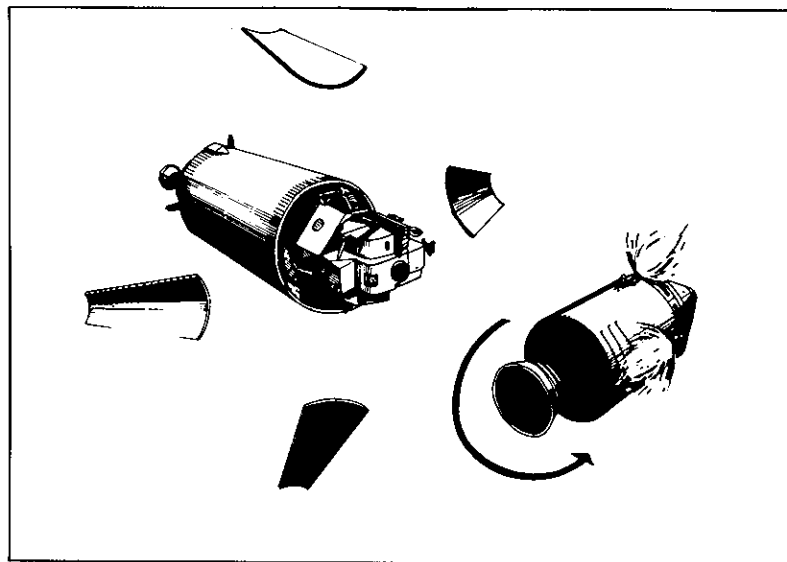

Transposition Maneuver

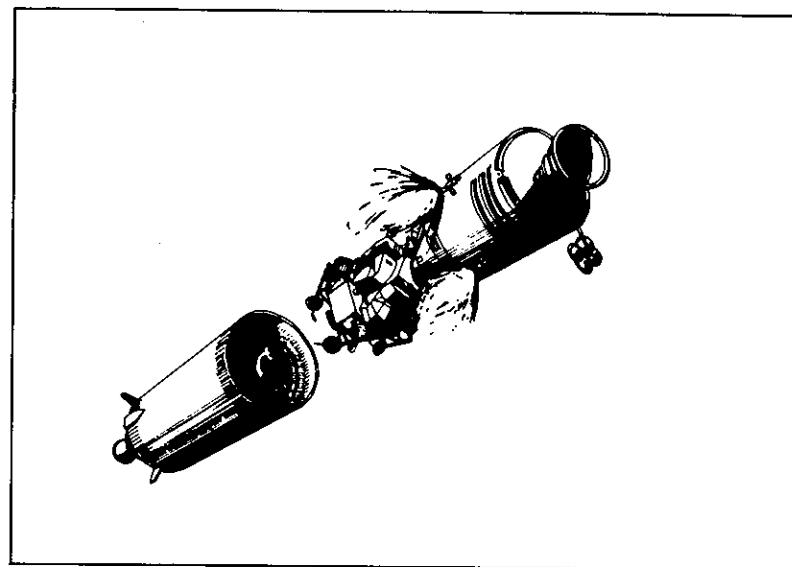

Extraction Of Lunar Module

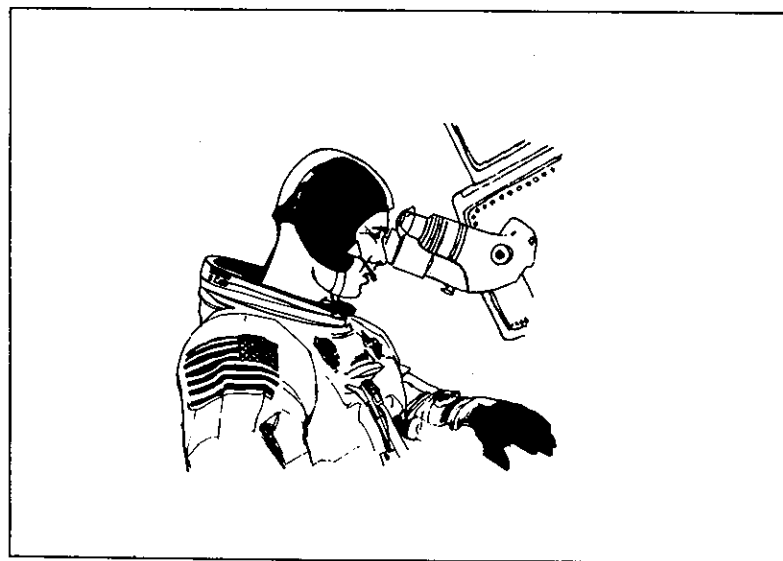

Navigation Check

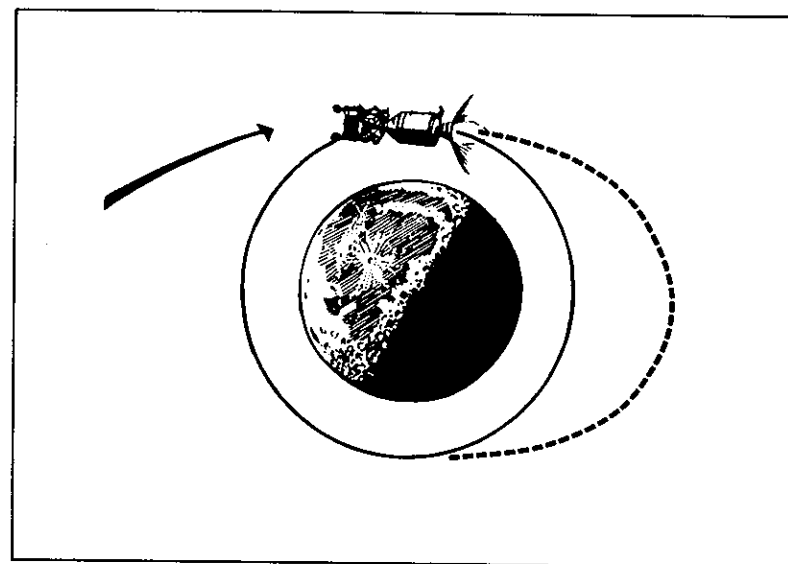

Lunar Orbit Insertion

-more-

-7-

After touchdown, the landing crew will first ready the lunar module for immediate ascent and then take a brief rest before depressurizing the cabin for two-man EVA about 10 hours after touchdown. Armstrong will step onto the lunar surface first, followed by Aldrin some 40 minutes later.

During their two hours and 40 minutes on the surface, Armstrong and Aldrin will gather geologic samples for return to Earth in sealed sample return containers and set up two scientific experiments for returning Moon data to Earth long after the mission is complete.

One experiment measures moonquakes and meteoroid impacts on the lunar surface, while the other experiment is a sophisticated reflector that will mirror laser beams back to points on Earth to aid in expanding scientific knowledge both of this planet and of the Moon.

The lunar module's descent stage will serve as a launching pad for the crew cabin as the 3,500-pound-thrust ascent engine propels the LM ascent stage back into lunar orbit for rendezvous with Collins in the command/service module--orbiting 60 miles above the Moon.

APOLLO 11 — Descent To Lunar Surface

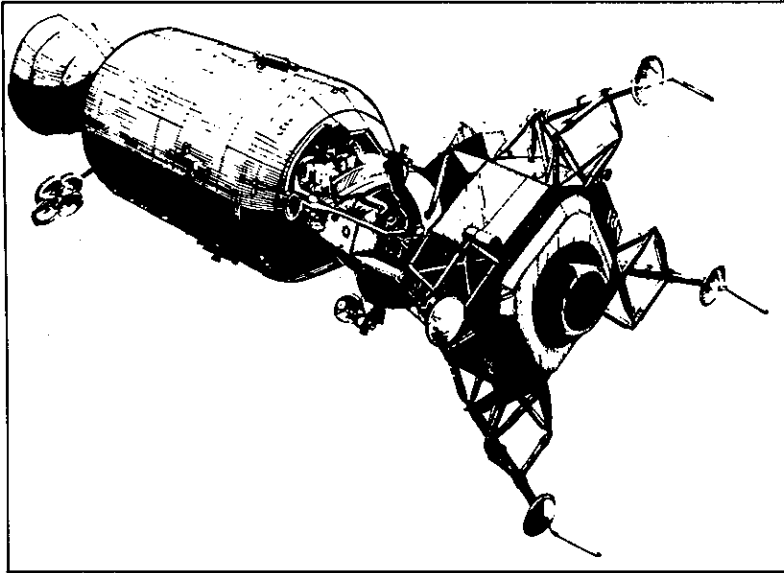

Transfer To LM

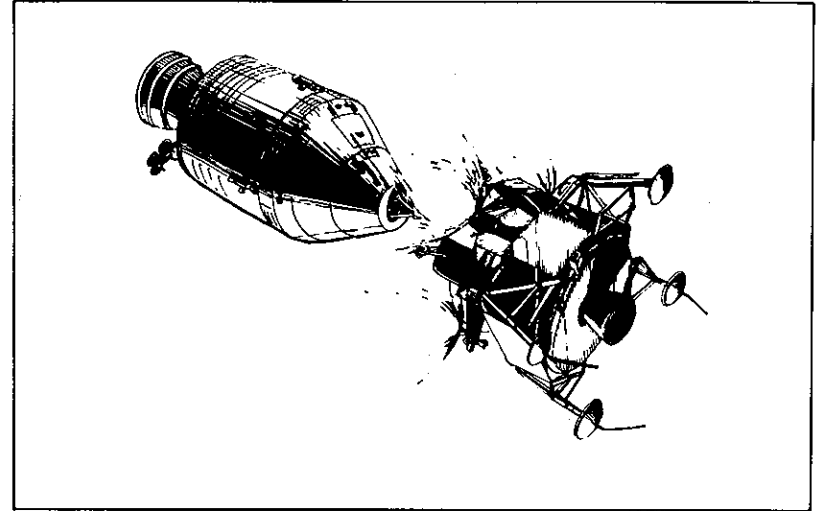

Separation Of LM From CSM

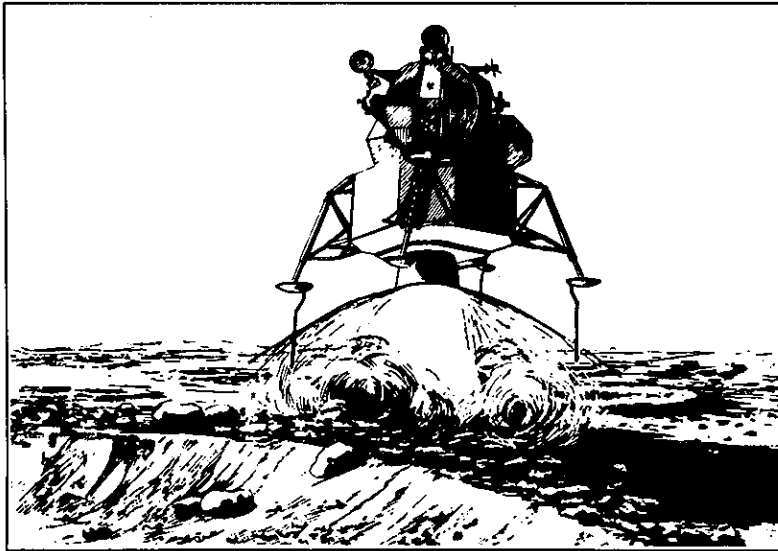

Landing On Moon

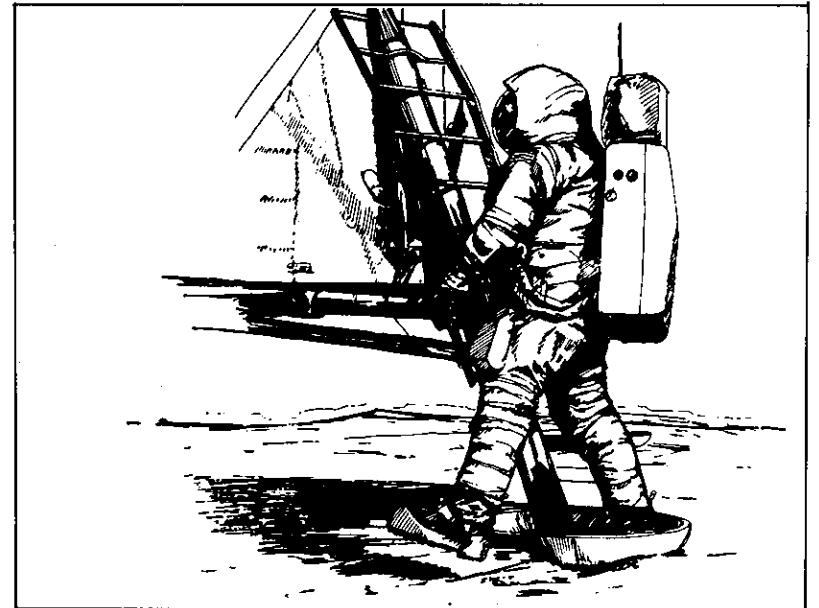

First Step On Moon

-more-

-9-

APOLLO 11 — Lunar Surface Activities



Commander On Moon

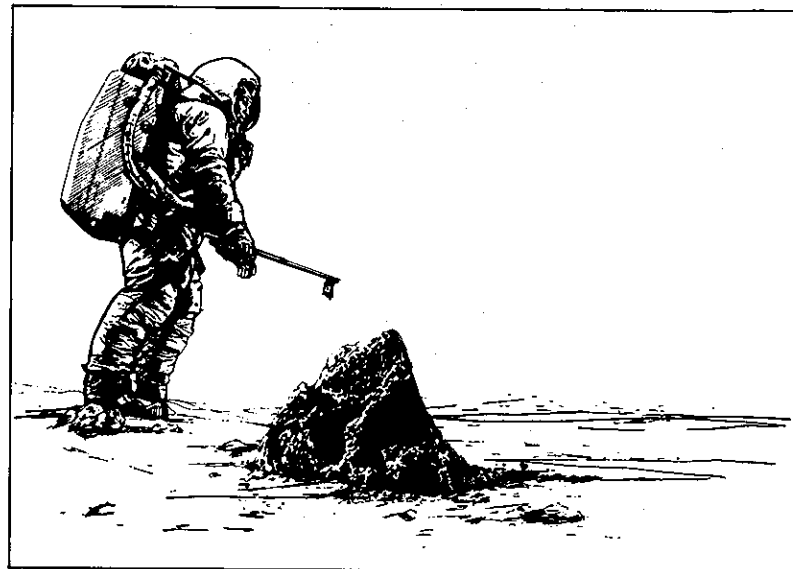

Contingency Sample

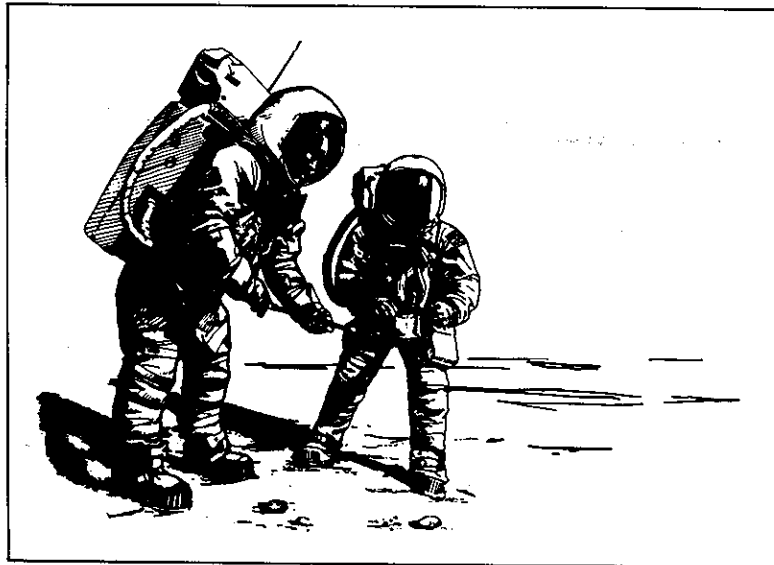

Documented Sample Collection

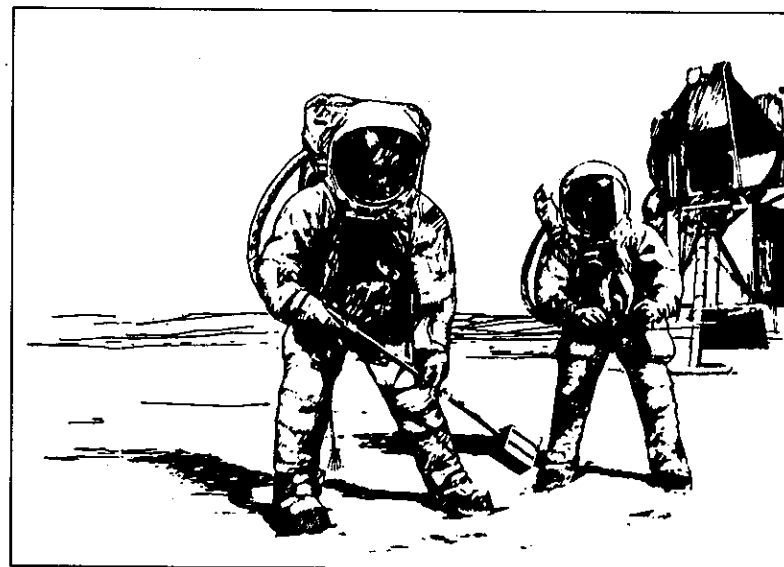

Sample Collecting

more-

-10-

APOLLO 11 — Lunar Surface Activities

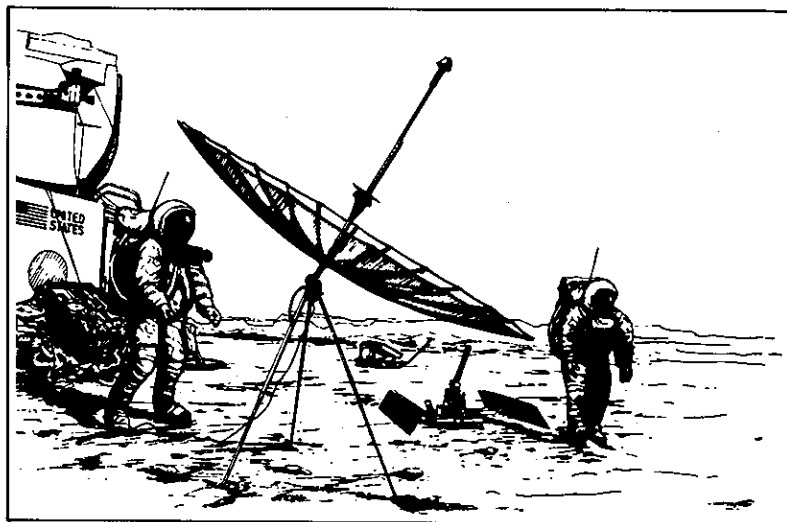

Experiment Placements



TV Camera



Alignment Of Passive
Seismometer



Bulk Sample Collection

-MORE-

-11-

Four basic maneuvers, all performed by the LM crew using the spacecraft's small maneuvering and attitude thrusters, will bring the LM and the command module together for docking about three and a half hours after liftoff from the Moon.

The boost out of lunar orbit for the return journey is planned for about 135 hours after Earth liftoff and after the LM ascent stage has been jettisoned and lunar samples and film stowed aboard the command module. An optional plan provides for a 12-hour delay in the transearth injection burn to allow the crew more rest after a long hard day's work on the lunar surface and flying the rendezvous. The total mission time to splashdown would remain about the same, since the transearth injection burn would impart a higher velocity to bring the spacecraft back to the mid-Pacific recovery line at about the same time.

The rendezvous sequence to be flown on Apollo 11 has twice been flown with the Apollo spacecraft---once in Earth orbit on Apollo 9 and once in lunar orbit with Apollo 10. The Apollo 10 mission duplicated, except for the actual landing, all aspects of the Apollo 11 timeline.

-more-

APOLLO 11 — Lunar Ascent And Rendezvous

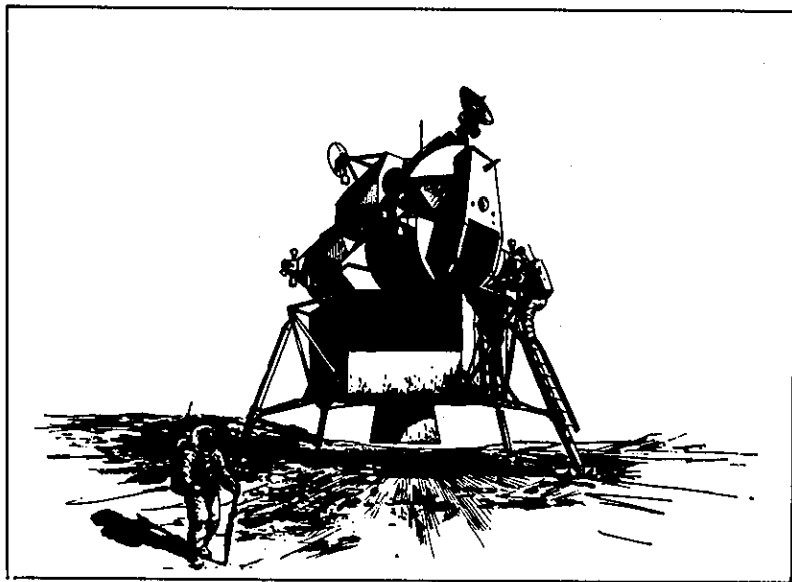

Return To Spacecraft

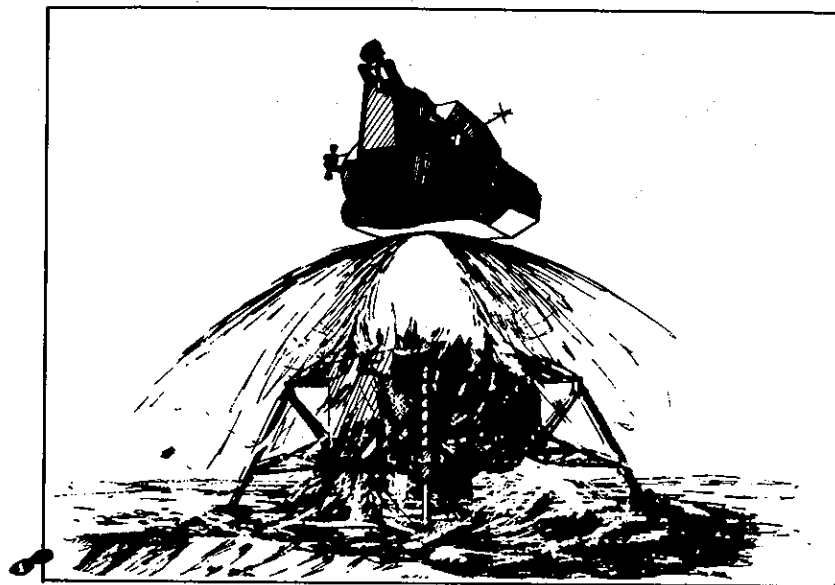

Ascent Stage Launch

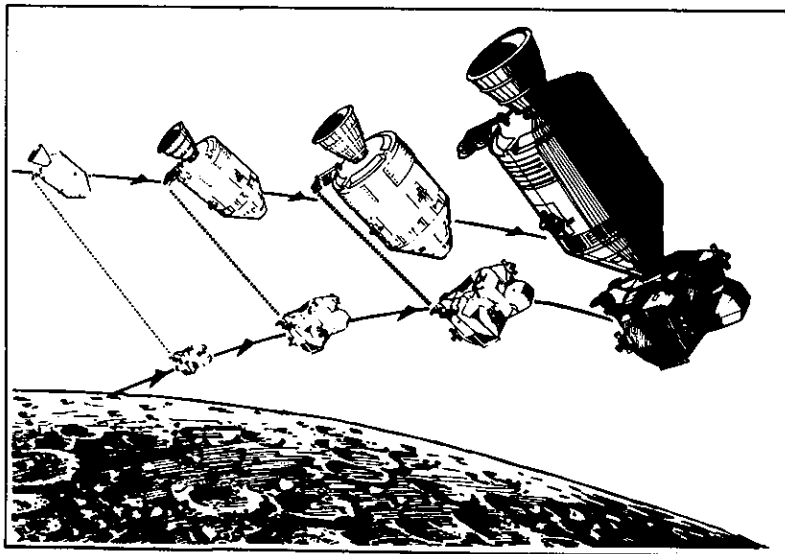

Rendezvous And Docking

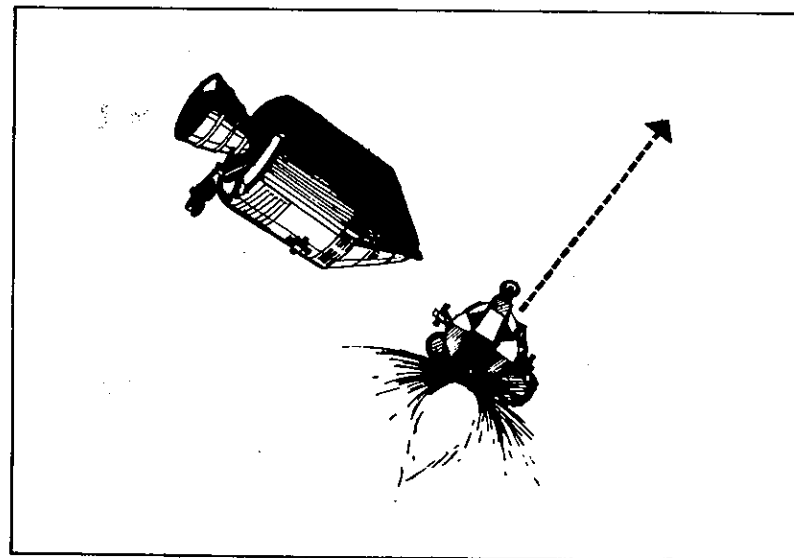

LM Jettison

-more-

-13-

APOLLO 11 — Transearth Injection And Recovery

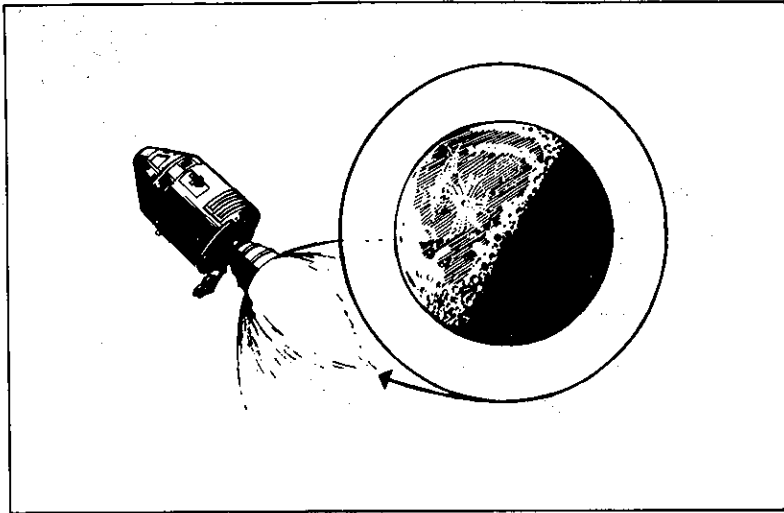

Transearth Injection

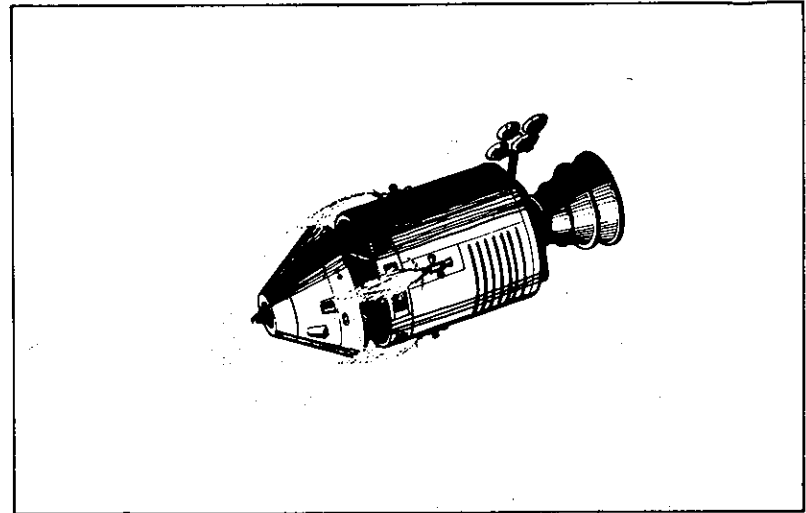

CM/SM Separation

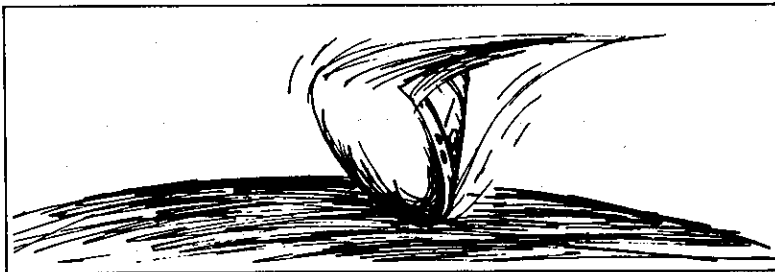

Reentry

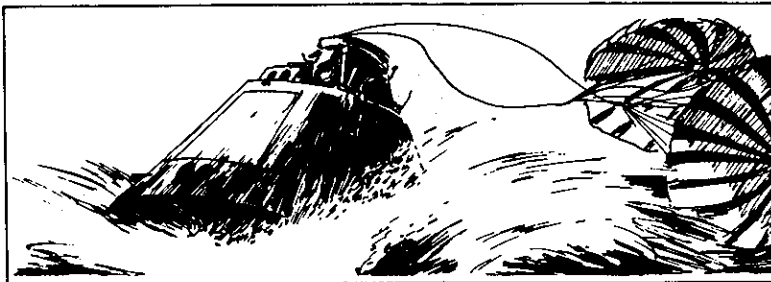

Splashdown

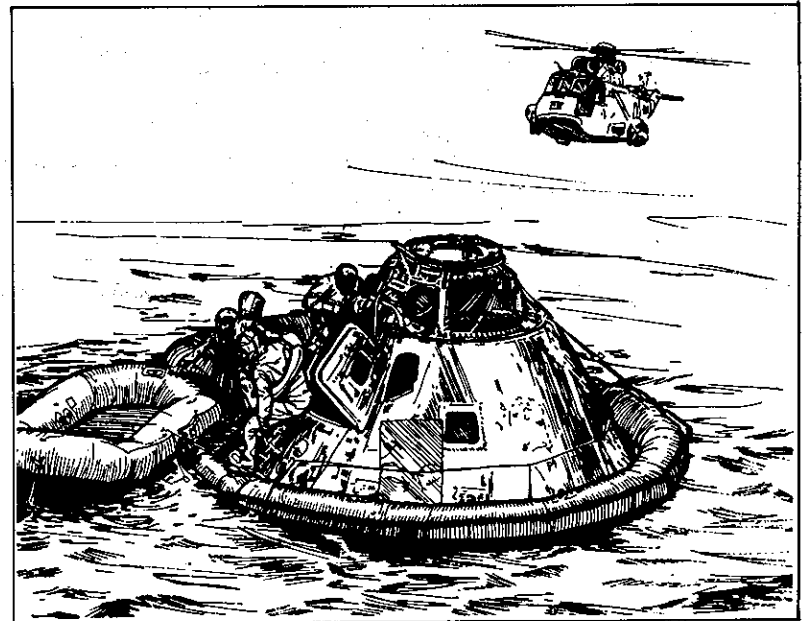

Recovery

-more-

-14-

During the transearth coast period, Apollo 11 will again control solar heat loads by using the passive thermal control "barbeque" technique. Three transearth midcourse corrections are possible and will be planned in real time to adjust the Earth entry corridor.

Apollo 11 will enter the Earth's atmosphere (400,000 feet) at 195 hours and five minutes after launch at 36,194 feet per second. Command module touchdown will be 1285 nautical miles downrange from entry at 10.6 degrees north latitude by 172.4 west longitude at 195 hours, 19 minutes after Earth launch 12:46 p.m. EDT July 24. The touchdown point is about 1040 nautical miles southwest of Honolulu, Hawaii.

(END OF GENERAL RELEASE; BACKGROUND INFORMATION FOLLOWS)

-more-

-16-

Official Apollo 11 Insignia

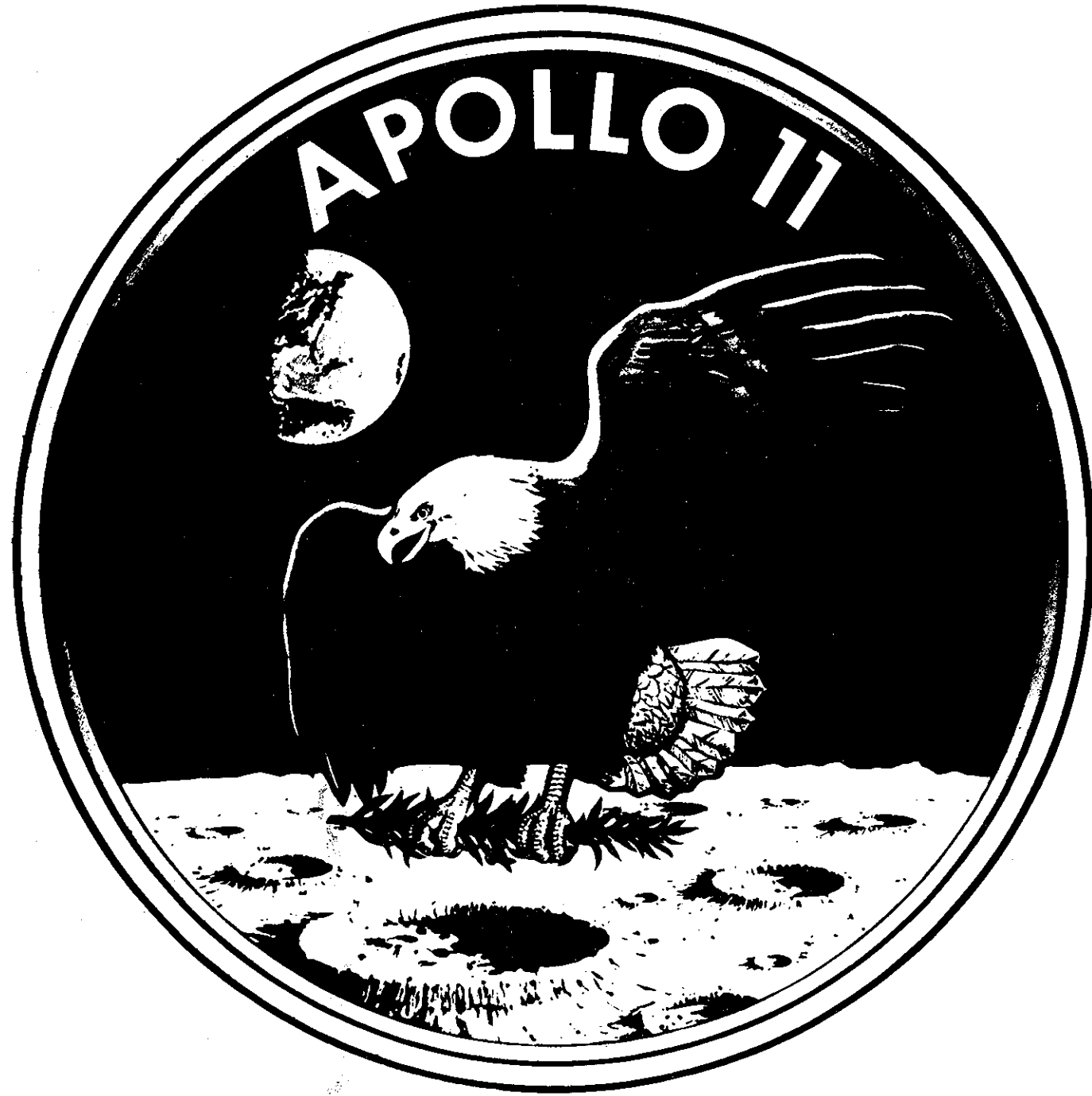

This photograph not for release
before Saturday, July 5, 1969

-more-

FLIGHT PROFILE

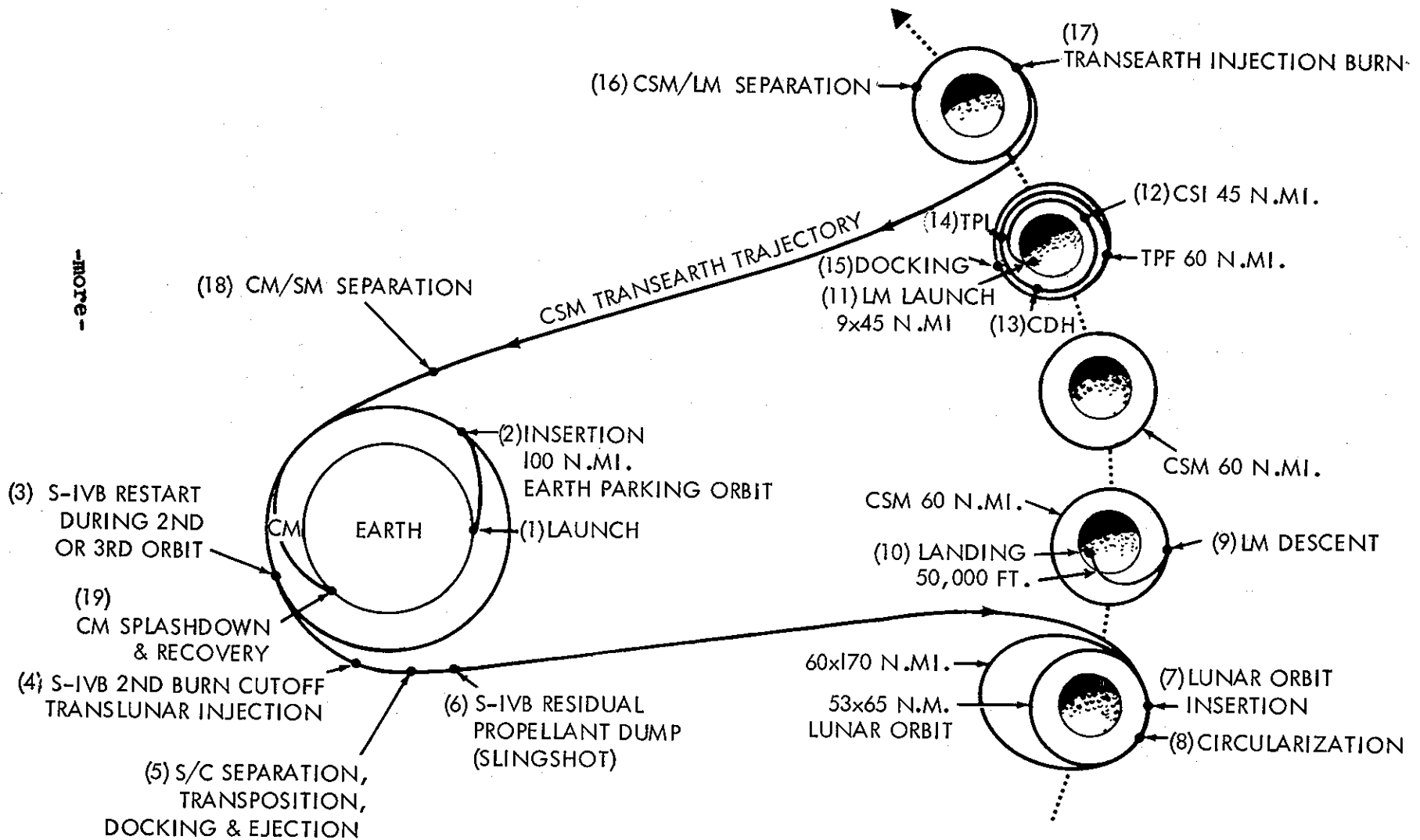

-more-

-17-

APOLLO 11 COUNTDOWN

The clock for the Apollo 11 countdown will start at T-28 hours, with a six-hour built-in-hold planned at T-9 hours, prior to launch vehicle propellant loading.

The countdown is preceded by a pre-count operation that begins some 5 days before launch. During this period the tasks include mechanical buildup of both the command/service module and LM, fuel cell activation and servicing and loading of the super critical helium aboard the LM descent stage.

Following are some of the highlights of the final count:

T-28 hrs.	Official countdown starts
T-27 hrs. 30 mins.	Install launch vehicle flight batteries (to 23 hrs. 30 mins.) LM stowage and cabin closeout (to 15 hrs.)
T-21 hrs.	Top off LM super critical helium (to 19 hrs.)
T-16 hrs.	Launch vehicle range safety checks (to 15 hrs.)
T-11 hrs. 30 mins.	Install launch vehicle destruct devices (to 10 hrs. 45 mins.) Command/service module pre-ingress operations
T-10 hrs.	Start mobile service structure move to park site
T-9 hrs.	Start six hour built-in-hold
T-9 hrs. counting	Clear blast area for propellant loading
T-8 hrs. 30 mins.	Astronaut backup crew to spacecraft for prelaunch checks
T-8 hrs. 15 mins.	Launch Vehicle propellant loading, three stages (liquid oxygen in first stage) liquid oxygen and liquid hydrogen in second, third stages. Continues thru T-3 hrs. 38 mins.

-more-

T-5 hrs. 17 mins.	Flight crew alerted
T-5 hrs. 02 mins.	Medical examination
T-4 hrs. 32 mins.	Breakfast
T-3 hrs. 57 mins.	Don space suits
T-3 hrs. 07 mins.	Depart Manned Spacecraft Operations Building for LC-39 via crew transfer van
T-2 hrs. 55 mins.	Arrive at LC-39
T-2 hrs. 40 mins.	Start flight crew ingress
T-1 hr. 55 mins.	Mission Control Center-Houston/spacecraft command checks
T-1 hr. 50 mins.	Abort advisory system checks
T-1 hr. 46 mins.	Space vehicle Emergency Detection System (EDS) test
T-43 mins.	Retract Apollo access arm to standby position (12 degrees)
T-42 mins.	Arm launch escape system
T-40 mins.	Final launch vehicle range safety checks (to 35 mins.)
T-30 mins.	Launch vehicle power transfer test LM switch over to internal power
T-20 mins. to T-10 mins.	Shutdown LM operational instrumentation
T-15 mins.	Spacecraft to internal power
T-6 mins.	Space vehicle final status checks
T-5 mins. 30 sec.	Arm destruct system
T-5 mins.	Apollo access arm fully retracted
T-3 mins. 10 sec.	Initiate firing command (automatic sequencer)
T-50 sec.	Launch vehicle transfer to internal power

T-8.9 sec.	Ignition sequence start
T-2 sec.	All engines running
T-0	Liftoff

*Note: Some changes in the above countdown are possible as a result of experience gained in the Countdown Demonstration Test (CDDT) which occurs about 10 days before launch.

-more-

LAUNCH EVENTS

Time			Event	Altitude	Velocity	Range
Hrs	Min	Sec		Feet	Ft/Sec	Nau Mi
00	00	00	First Motion	182.7	1,340.67	0.0
00	01	21.0	Maximum Dynamic Pressure	43,365	2,636.7	2.7
00	02	15	S-IC Center Engine Cutoff	145,600	6,504.5	24.9
00	02	40.8	S-IC Outboard Engines Cutoff	217,655	9,030.6	49.6
00	02	41.6	S-IC/S-II Separation	219,984	9,064.5	50.2
00	02	43.2	S-II Ignition	221,881	9,059.1	51.3
00	03	11.5	S-II Aft Interstage Jettison	301,266	9,469.0	87.0
00	03	17.2	LET Jettison	315,001	9,777.6	94.3
00	07	39.8	S-II Center Engine Cutoff	588,152	18,761.7	600.0
00	09	11.4	S-II Outboard Engines Cutoff	609,759	22,746.8	885.0
00	09	12.3	S-II/S-IVB Separation	609,982	22,756.7	887.99
00	09	15.4	S-IVB Ignition	610,014	22,756.7	888.42
00	11	40.1	S-IVB First Cutoff	617,957	25,562.4	1425.2
00	11	50.1	Parking Orbit Insertion	617,735	25,567.9	1463.9
02	44	14.8	S-IVB Reignition	650,558	25,554.0	3481.9
02	50	03.1	S-IVB Second Cutoff	1058,809	35,562.9	2633.6
02	50	13.1	Translunar Injection	1103,215	35,538.5	2605.0

-more-

APOLLO 11 MISSION EVENTS

<u>Event</u>	<u>GET</u> hrs:min:sec	<u>Date/EDT</u>	<u>Vel.Change</u> feet/sec	<u>Purpose and resultant orbit</u>
Lunar orbit insertion No. 1	75:54:28	19th 1:26 p	-2924	Inserts Apollo 11 into 60 x 170 nm elliptical lunar orbit
Lunar orbit insertion No. 2	80:09:30	19th 5:42 p	-157.8	Changes lunar parking orbit to 54 x 66 nm
CSM-LM undocking, separation (SM RCS)	100:09:50	20th 1:42 p	--	Establishes equiperiod orbit for 2.2 nm separation for DOI maneuver
	100:39:50	20th 2:12 p	2.5	
Descent orbit insertion (DPS)	101:38:48	20th 3:12 p	-74.2	Lowers LM pericyynthion to 8 nm (8 x 60)
LM powered descent ini- tiation (DPS)	102:35:13	20th 4:08 p	-6761	Three-phase maneuver to brake LM out of transfer orbit, vertical descent and touchdown on lunar surface
LM touchdown on lunar surface	102:47:11	20th 4:19 p		Lunar exploration
Depressurization for lunar surface EVA	112:30	21st 2:02 a		
Repressurize LM after EVA	115:10	21st 4:42 a		

-more-

121

APOLLO 11 MISSION EVENTS

<u>Event</u>	<u>GET</u> hrs:min:sec	<u>Date/EDT</u>	<u>Vel.Change</u> feet/sec	<u>Purpose and resultant orbit</u>
Earth orbit insertion	00:11:50	16th 9:44 a	25,567	Insertion into 100 nm circular earth parking orbit
Translunar injection (S-IVB engine ignition)	02:44:15	16th 12:16 p	9,965	Injection into free-return translunar trajectory with 60 nm pericyynthion
CSM separation, docking	03:20:00	16th 12:52 p	--	Hard-mating of CSM and LM
Ejection from SLA	04:10:00	16th 1:42 p	1	Separates CSM-LM from S-IVB-SLA
SPS Evasive maneuver	04:39:37	16th 2:12 p	19.7	Provides separation prior to S-IVB propellant dump and "slingshot" maneuver
Midcourse correction #1	TLI+9 hrs	16th 9:16 p	*0	*These midcourse corrections have a nominal velocity change of 0 fps, but will be calculated in real time to correct TLI dispersions.
Midcourse correction #2	TLI+24 hrs	17th 12:16 p	0	
Midcourse correction #3	LOI-22 hrs	18th 3:26 p	0	
Midcourse correction #4	LOI-5 hrs	19th 8:26 a	0	

-more-

-23-

APOLLO 11 MISSION EVENTS

<u>Event</u>	<u>GET</u> hrs:min:sec	<u>DATE/EDT</u>	<u>Vel.Change</u> feet/sec	<u>Purpose and resultant orbit</u>
LM ascent and orbit insertion	124:23:21	21st 1:55 p	6055	Boosts ascent stage into 9 x 45 lunar orbit for rendezvous with CSM
LM RCS concentric sequence initiate (CSI) burn	125:21:20	21st 2:53 p	49.4	Raises LM perilune to 44.7 nm, adjusts orbital shape for rendezvous sequence (45.5 x 44.2)
LM RCS constant delta height (CDH) burn	126:19:40	21st 3:52 p	4.5	Radially downward burn adjusts LM orbit to constant 15 nm below CSM
LM RCS terminal phase initiate (TPI) burn	126:58:26	21st 4:30 p	24.6	LM thrusts along line of sight toward CSM, midcourse and braking maneuvers as necessary
Rendezvous (TPF)	127:43:54	21st 5:15 p	-4.7	Completes rendezvous sequence (59.5 x 59.0)
Docking	128:00:00	21st 5:32 p	--	Commander and LM pilot transfer back to CSM
LM jettison, separation (SM RCS)	131:53:05	21st 9:25 p	-1	Prevents recontact of CSM with LM ascent stage during remainder of lunar orbit
Transearth injection (TEI) SPS	135:24:34	22nd 00:57 a	3293	Inject CSM into 59.6-hour trans-earth trajectory

- info -

-24-

APOLLO 11 MISSION EVENTS

<u>Event</u>	<u>GET</u> hrs:min:sec	<u>DATE/EDT</u>	<u>Vel.Change</u> feet/sec	<u>Purpose and resultant orbit</u>
Midcourse correction No. 5	TEI+15 hrs	22nd 3:57 p	0	Transearch midcourse corrections will be computed in real time for entry corridor control and recovery area weather avoidance.
Midcourse correction No. 6	EI -15 hrs	23rd 9:37 p	0	
Midcourse correction No. 7	EI -3 hrs	24th 9:37 a	0	
CM/SM separation	194:50:04	24th 12:22 p	--	Command module oriented for entry
Entry interface (400,000 feet)	195:05:04	24th 12:37 p	--	Command module enters earth's sensible atmosphere at 36,194 fps
Touchdown	195:19:05	24th 12:51 p	--	Landing 1285 nm downrange from entry, 10.6 north latitude by 172.4 west longitude.

-more-

-25-

MISSION TRAJECTORY AND MANEUVER DESCRIPTION

Information presented herein is based upon a July 16 launch and is subject to change prior to the mission or in real time during the mission to meet changing conditions.

Launch

Apollo 11 will be launched from Kennedy Space Center Launch Complex 39A on a launch azimuth that can vary from 72 degrees to 106 degrees, depending upon the time of day of launch. The azimuth changes with time of day to permit a fuel-optimum injection from Earth parking orbit into a free-return circumlunar trajectory. Other factors influencing the launch windows are a daylight launch and proper Sun angles on the lunar landing sites.

The planned Apollo 11 launch date of July 16 will call for liftoff at 9:32 a.m. EDT on a launch azimuth of 72 degrees. The 7.6-million-pound thrust Saturn V first stage boosts the space vehicle to an altitude of 36.3 nm at 50.6 nm downrange and increases the vehicle's velocity to 9030.6 fps in 2 minutes 40.8 seconds of powered flight. First stage thrust builds to 9,088,419 pounds before center engine shutdown. Following out-board engine shutdown, the first stage separates and falls into the Atlantic Ocean about 340 nm downrange (30.3 degrees North latitude and 73.5 degrees West longitude) some 9 minutes after liftoff.

The 1-million-pound thrust second stage (S-II) carries the space vehicle to an altitude of 101.4 nm and a distance of 885 nm downrange. Before engine burnout, the vehicle will be moving at a speed of 22,746.8 fps. The outer J-2 engines will burn 6 minutes 29 seconds during this powered phase, but the center engine will be cut off at 4 minutes 56 seconds after S-II ignition.

At outboard engine cutoff, the S-II separates and, following a ballistic trajectory, plunges into the Atlantic Ocean about 2,300 nm downrange from the Kennedy Space Center (31 degrees North latitude and 33.6 degrees West longitude) some 20 minutes after liftoff.

The first burn of the Saturn V third stage (S-IVB) occurs immediately after S-II stage separation. It will last long enough (145 seconds) to insert the space vehicle into a circular Earth parking orbit beginning at about 4,818 nm downrange. Velocity at Earth orbital insertion will be 25,567 fps at 11 minutes 50 seconds ground elapsed time (GET). Inclination will be 32.6 degrees.

-more-

LAUNCH WINDOW SUMMARY

<p style="text-align: center;">LAUNCH DATE</p> <p>JULY 16-21</p> <p>LAUNCH WINDOW, E.D.T. SITE/PROFILE SUN ELEVATION ANGLE MISSION TIME, DAYS:HOURS SPS RESERVES, FPS</p>	<p style="text-align: center;">16</p> <p>9:32-13:54 2/FR 9.9-12.6 8:3 1700</p>		<p style="text-align: center;">18</p> <p>9:38-14:02 3/FR 8.3-11.0 8:5 1550</p>			<p style="text-align: center;">21</p> <p>10:09-14:39 5/HYB 6.3-9.0 8:8 1750</p>	
<p style="text-align: center;">LAUNCH DATE</p> <p>AUGUST 14-20</p> <p>LAUNCH WINDOW, E.D.T. SITE/PROFILE SUN ELEVATION ANGLE MISSION TIME, DAYS:HOURS SPS RESERVES, FPS</p>	<p style="text-align: center;">14</p> <p>7:51-12:15 2/HYB 6.2-8.9 8:5 1600</p>		<p style="text-align: center;">16</p> <p>8:04-12:31 3/HYB 6.2-8.9 8:7 1750</p>				<p style="text-align: center;">20</p> <p>10:05-14:47 5/HYB 9.0-12.0 8:8 1300</p>
<p style="text-align: center;">LAUNCH DATE</p> <p>SEP 13-18</p> <p>LAUNCH WINDOW, E.D.T. SITE/PROFILE SUN ELEVATION ANGLE MISSION TIME, DAYS:HOURS SPS RESERVES, FPS</p>	<p style="text-align: center;">13</p> <p>6:17-10:45 2/HYB 6.8-9.6 8:7 1600</p>		<p style="text-align: center;">15</p> <p>7:04-11:39 3/HYB 6.3-9.2 8:8 1500</p>			<p style="text-align: center;">18</p> <p>11:31-16:14 5/HYB 6.8-9.7 8:6 1050</p>	

MISSION DURATIONS

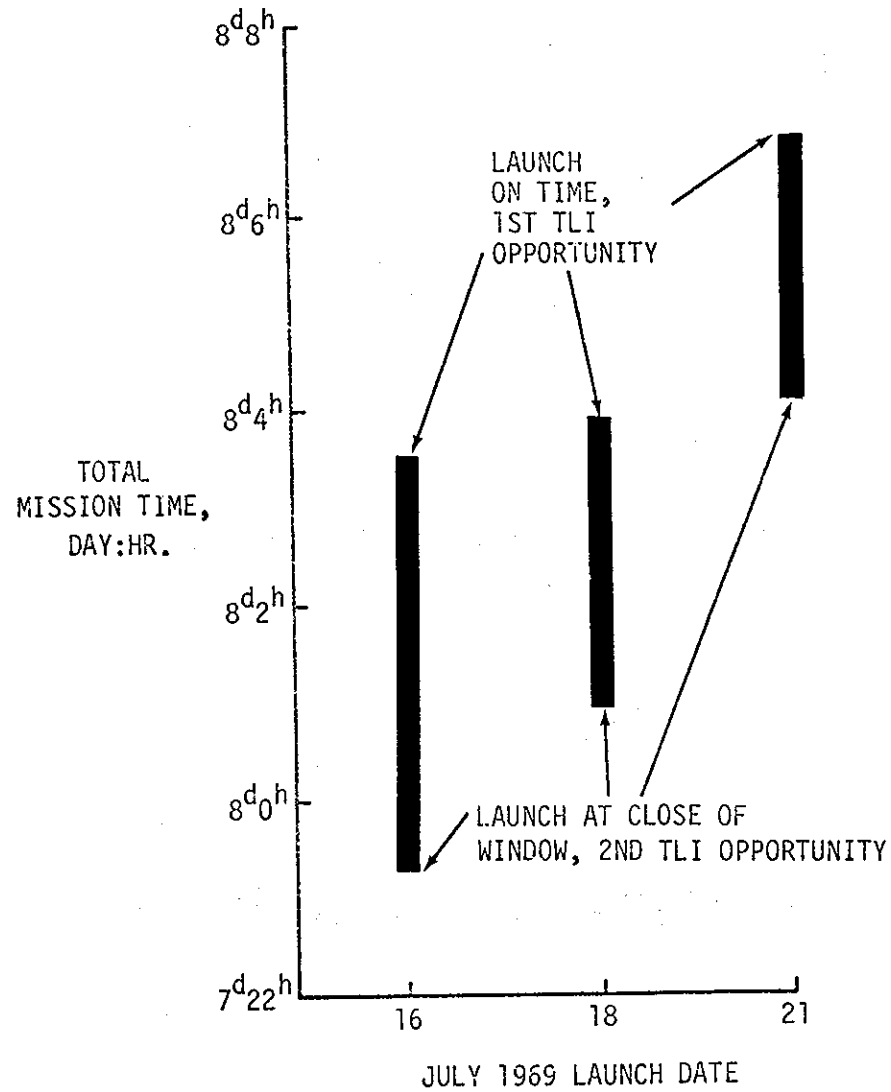

HYBRID LUNAR PROFILE

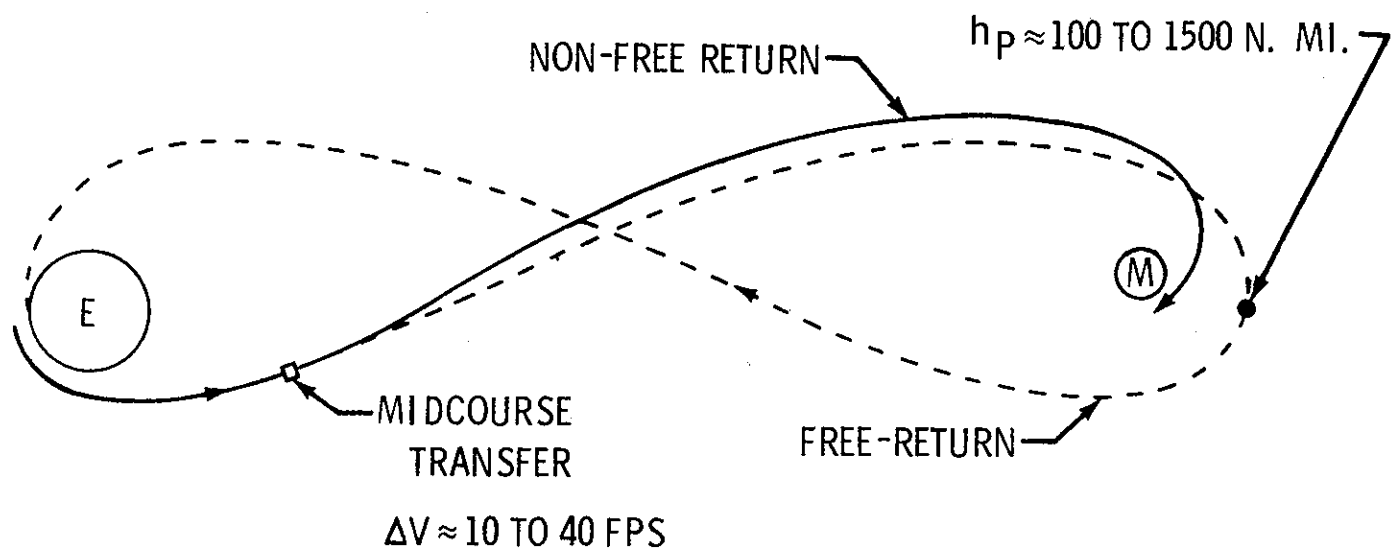

-more-

The crew will have a backup to launch vehicle guidance during powered flight. If the Saturn instrument unit inertial platform fails, the crew can switch guidance to the command module systems for first-stage powered flight automatic control. Second and third stage backup guidance is through manual takeover in which crew hand controller inputs are fed through the command module computer to the Saturn instrument unit.

Earth Parking Orbit (EPO)

Apollo 11 will remain in Earth parking orbit for one-and-one-half revolutions after insertion and will hold a local horizontal attitude during the entire period. The crew will perform spacecraft systems checks in preparation for the translunar injection (TLI) burn. The final "go" for the TLI burn will be given to the crew through the Carnarvon, Australia, Manned Space Flight Network station.

Translunar Injection (TLI)

Midway through the second revolution in Earth parking orbit, the S-IVB third-stage engine will restart at 2:44:15 GET over the mid-Pacific just south of the equator to inject Apollo 11 toward the Moon. The velocity will increase from 25,567 fps to 35,533 fps at TLI cutoff--a velocity increase of 9971 fps. The TLI burn is targeted for about 6 fps overspeed to compensate for the later SPS evasive maneuver after LM extraction. TLI will place Apollo 11 on a free-return circumlunar trajectory from which midcourse corrections if necessary could be made with the SM RCS thrusters. Entry from a free-return trajectory would be at 10:37 a.m. EDT July 22 at 14.9 degrees south latitude by 174.9 east longitude after a flight time of 145 hrs 04 min.

Transposition, Docking and Ejection (TD&E)

At about three hours after liftoff and 25 minutes after the TLI burn, the Apollo 11 crew will separate the command/service module from the spacecraft lunar module adapter (SLA), thrust out away from the S-IVB, turn around and move back in for docking with the lunar module. Docking should take place at about three hours and 21 minutes GET, and after the crew confirms all docking latches solidly engaged, they will connect the CSM-to-LM umbilicals and pressurize the LM with the command module surge tank. At about 4:09 GET, the spacecraft will be ejected from the spacecraft LM adapter by spring devices at the four LM landing gear "knee" attach points. The ejection springs will impart about one fps velocity to the spacecraft. A 19.7 fps service propulsion system (SPS) evasive maneuver in plane at 4:39 GET will separate the spacecraft to a safe distance for the S-IVB "slingshot" maneuver in which residual launch vehicle liquid propellants will be dumped through the J-2 engine bell to propel the stage into a trajectory passing behind the Moon's trailing edge and on into solar orbit.

-more-

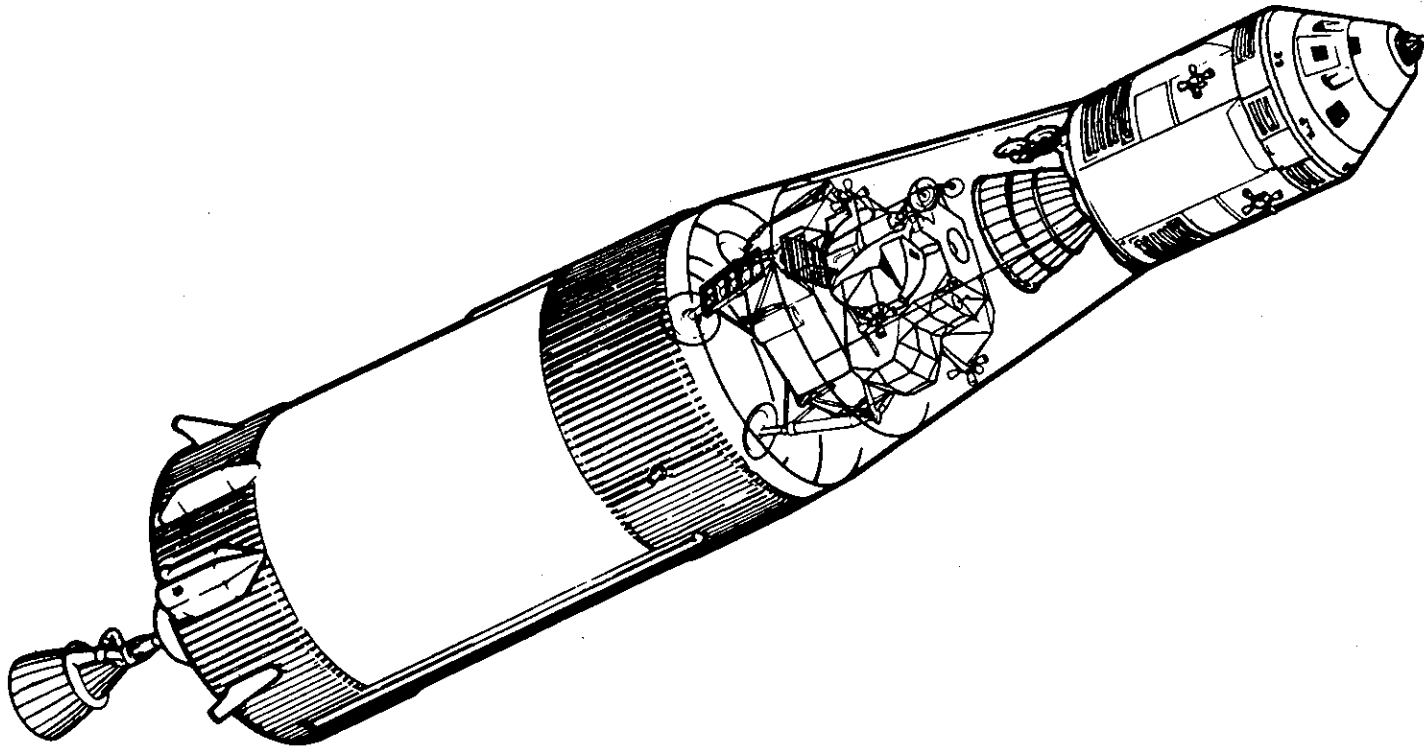

-31-

VEHICLE EARTH PARKING ORBIT CONFIGURATION

(SATURN V THIRD STAGE AND INSTRUMENT UNIT, APOLLO SPACECRAFT)

POST TLI TIMELINE

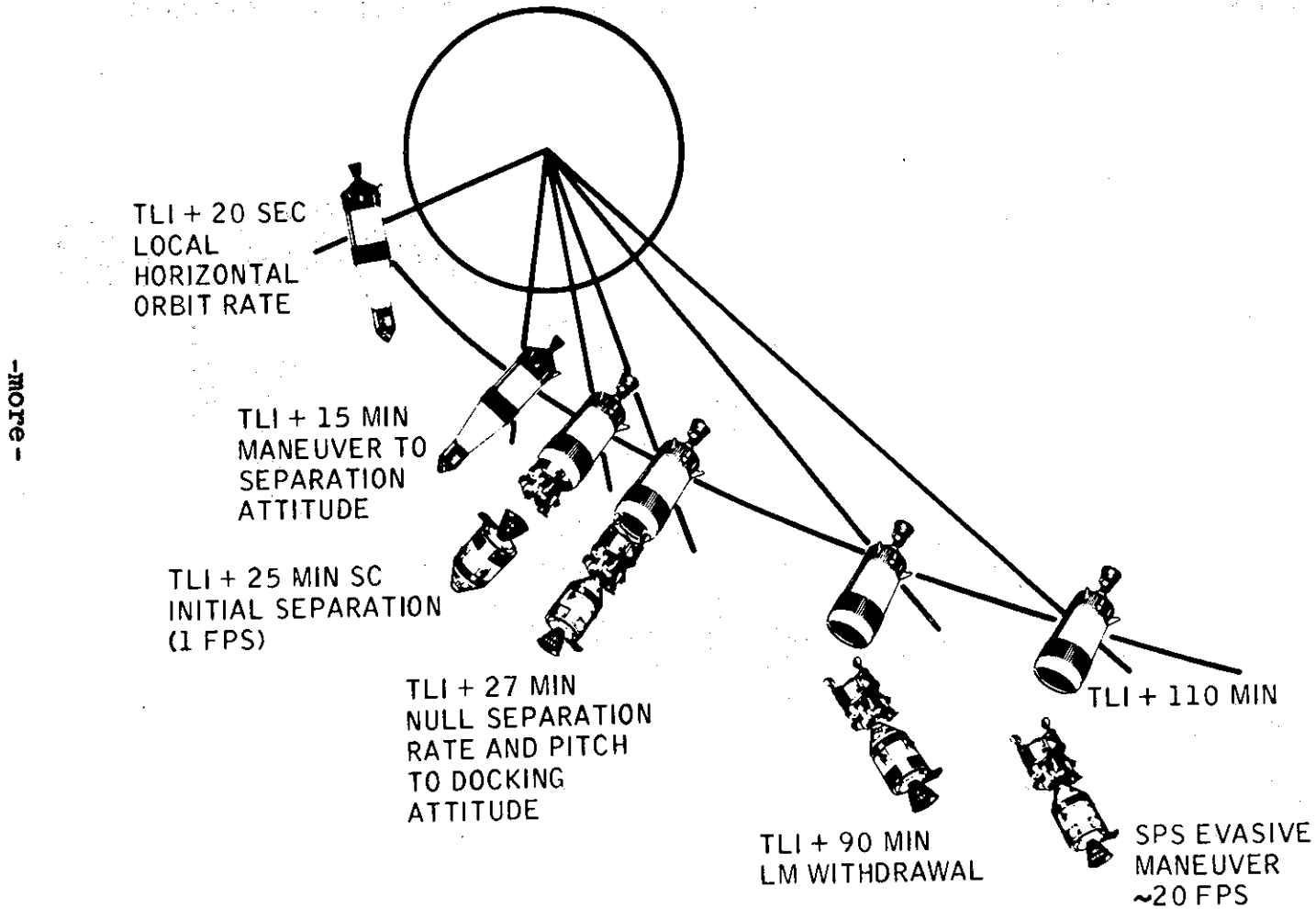

Translunar Coast

Up to four midcourse correction burns are planned during the translunar coast phase, depending upon the accuracy of the trajectory resulting from the TLI maneuver. If required, the midcourse correction burns are planned at TLI +9 hours, TLI +24 hours, lunar orbit insertion (LOI) -22 hours and LOI -5 hours.

During coast periods between midcourse corrections, the spacecraft will be in the passive thermal control (PTC) or "barbecue" mode in which the spacecraft will rotate slowly about one axis to stabilize spacecraft thermal response to the continuous solar exposure.

Lunar Orbit Insertion (LOI)

The first of two lunar orbit insertion burns will be made at 75:54:28 GET at an altitude of about 80 nm above the Moon. LOI-1 will have a nominal retrograde velocity change of 2,924 fps and will insert Apollo 11 into a 60x170-nm elliptical lunar orbit. LOI-2 two orbits later at 80:09:30 GET will adjust the orbit to a 54x65-nm orbit, which because of perturbations of the lunar gravitational potential, will become circular at 60 nm at the time of rendezvous with the LM. The burn will be 157.8 fps retrograde. Both LOI maneuvers will be with the SPS engine near pericyynthion when the spacecraft is behind the Moon and out of contact with MSFN stations. After LOI-2 (circularization), the lunar module pilot will enter the lunar module for a brief checkout and return to the command module.

Lunar Module Descent, Lunar Landing

The lunar module will be manned and checked out for undocking and subsequent landing on the lunar surface at Apollo site 2. Undocking will take place at 100:09:50 GET prior to the MSFN acquisition of signal. A radially downward service module RCS burn of 2.5 fps will place the CSM on an equiperiod orbit with a maximum separation of 2.2 nm one half revolution after the separation maneuver. At this point, on lunar farside, the descent orbit insertion burn (DOI) will be made with the lunar module descent engine firing retrograde 74.2 fps at 101:38:48 GET. The burn will start at 10 per cent throttle for 15 seconds and the remainder at 40 per cent throttle.

The DOI maneuver lowers LM pericynthion to 50,000 feet at a point about 14 degrees uprange of landing site 2.

A three-phase powered descent initiation (PDI) maneuver begins at pericyynthion at 102:53:13 GET using the LM descent engine to brake the vehicle out of the descent transfer orbit. The guidance-controlled PDI maneuver starts about 260 nm prior to touchdown, and is in retrograde attitude to reduce velocity to essentially zero at the time vertical descent begins. Spacecraft attitudes range from windows down at the start of PDI, to windows up as the spacecraft reaches 45,000 feet above the lunar surface and LM landing radar data can be integrated by the LM guidance computer. The braking phase ends at about 7,000 feet above the surface and the spacecraft is rotated to an upright windows-forward attitude. The start of the approach phase is called high gate, and the start of the landing phase at 500 feet is called low gate.

Both the approach phase and landing phase allow pilot take-over from guidance control as well as visual evaluation of the landing site. The final vertical descent to touchdown begins at about 150 feet when all forward velocity is nulled out. Vertical descent rate will be three fps. Touchdown will take place at 102:47:11 GET.

LUNAR ORBIT INSERTION

-more-

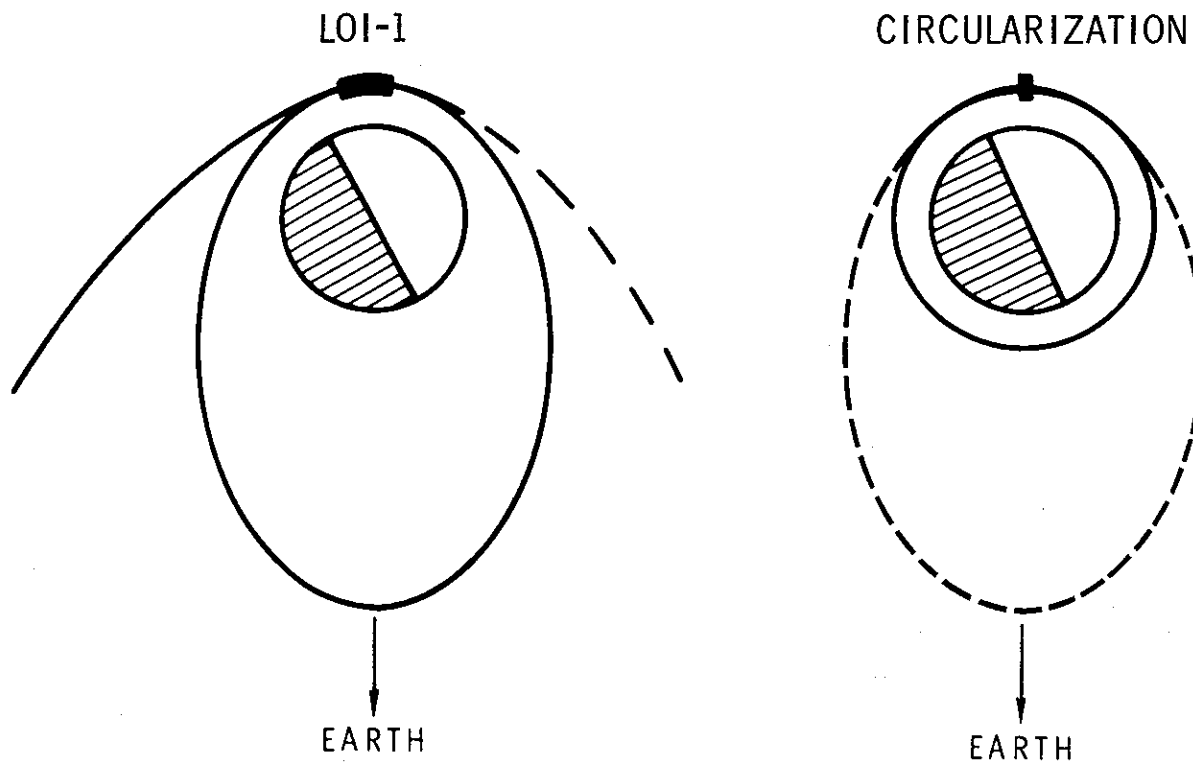

-MORE-

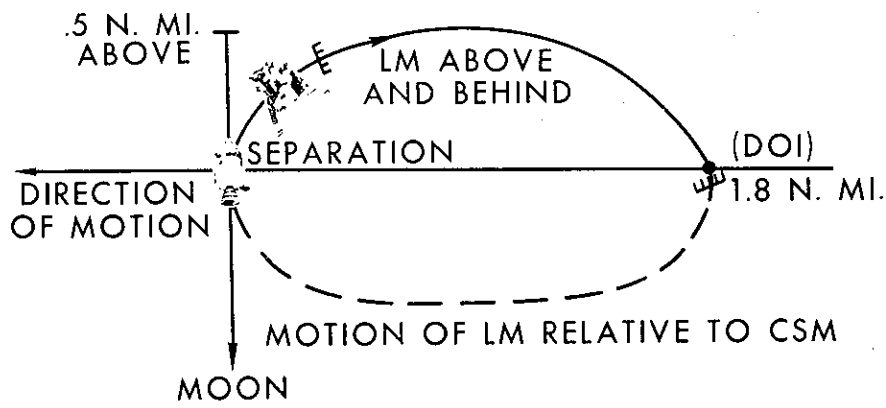

 SURFACE DARKNESS
 SC DARKNESS

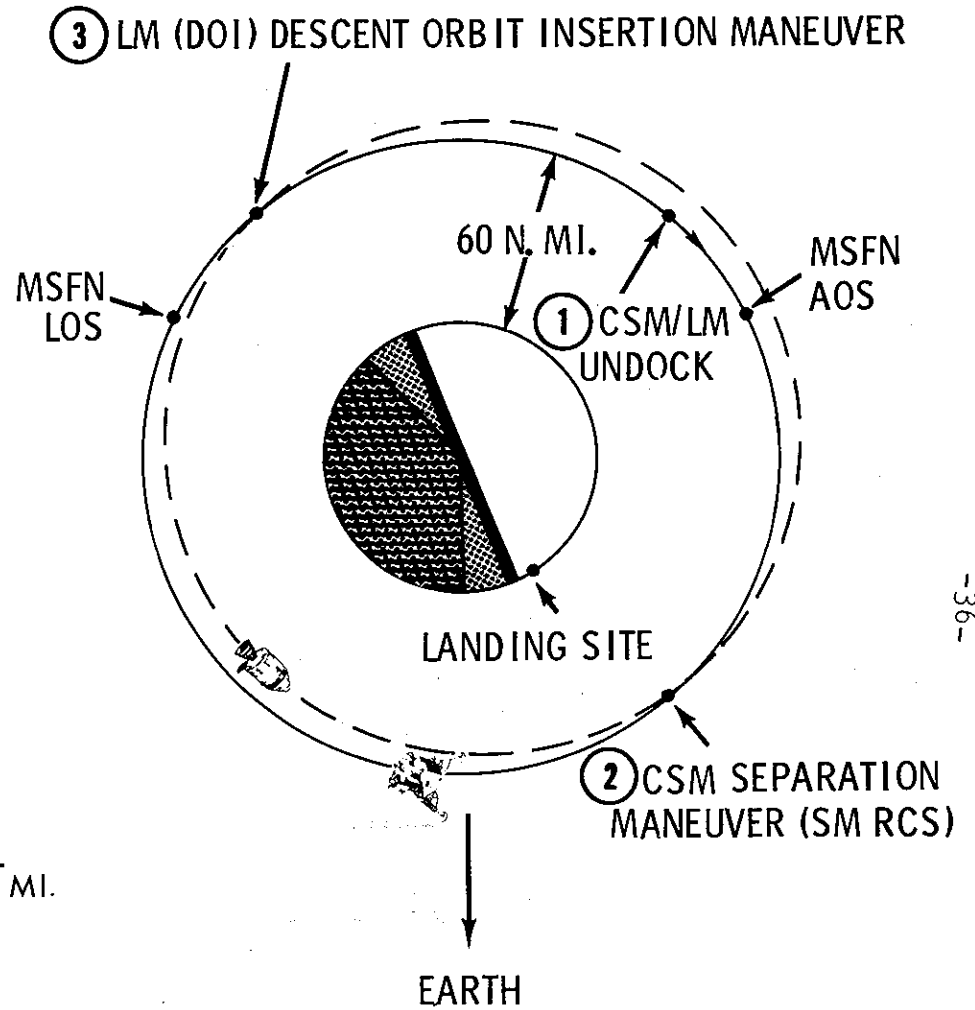

-36-

CSM/LM SEPARATION MANEUVER

LUNAR MODULE DESCENT

③ LM DESCENT ORBIT INSERTION (DOI) MANUEVER, RETROGRADE, DPS -THROTTLED TO 40%

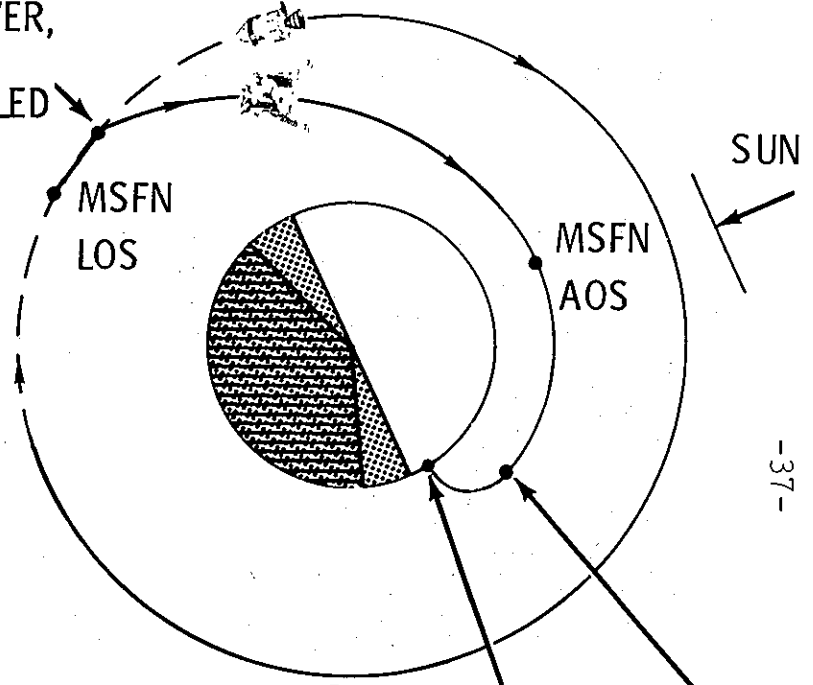

④ POWERED DESCENT INITIATION 50,000 FT. ALTITUDE
 ⑤ LANDING

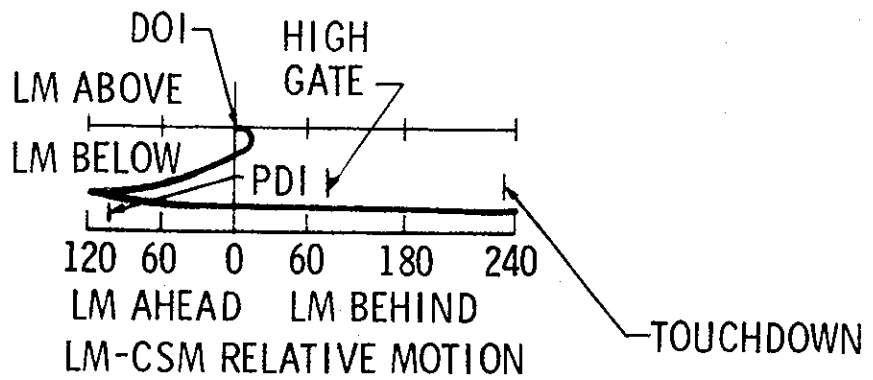

-more-

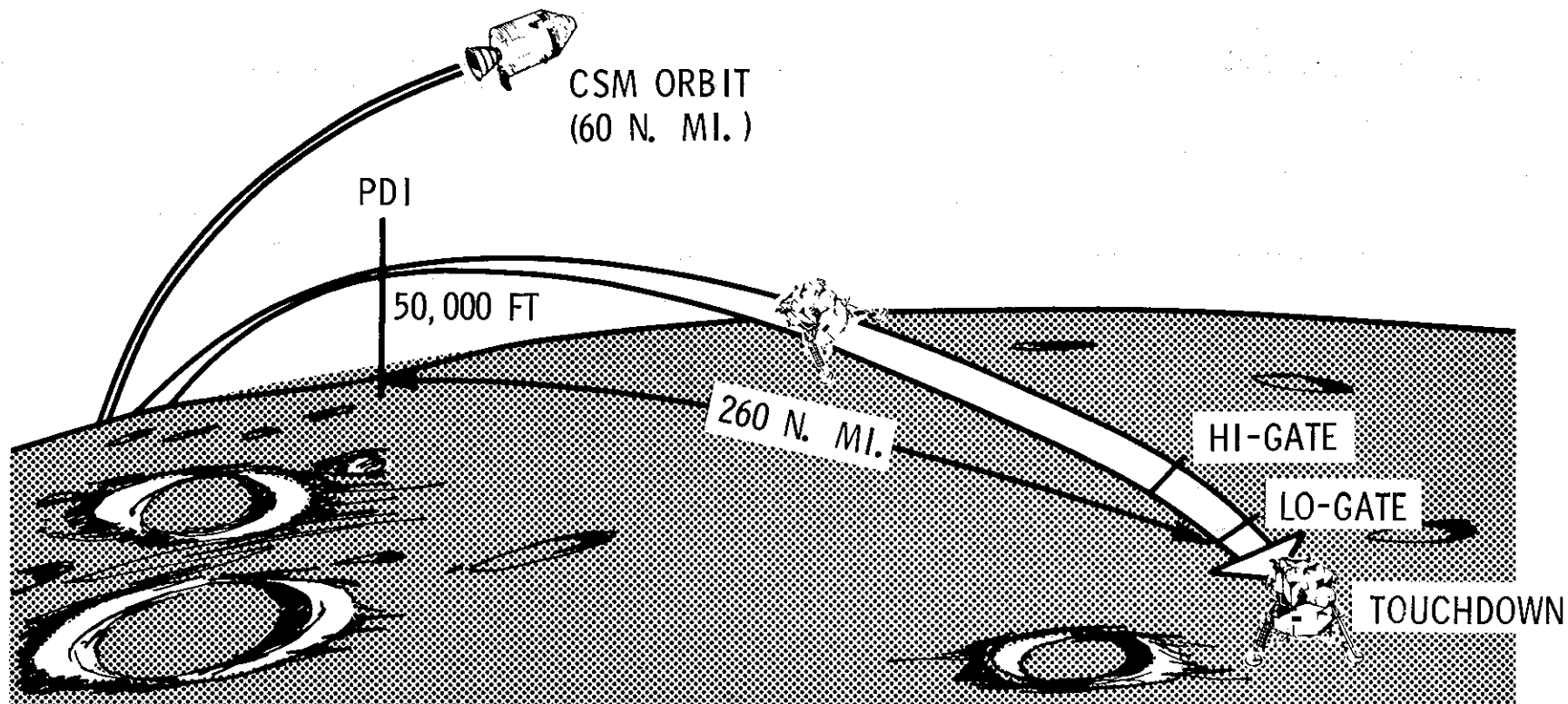

DESIGN CRITERIA

- BRAKING PHASE (PDI TO HI-GATE) - EFFICIENT REDUCTION OF ORBITAL VELOCITY
- FINAL APPROACH PHASE (HI-GATE TO LO-GATE) - CREW VISIBILITY (SAFETY OF FLIGHT AND SITE ASSESSMENT)
- LANDING PHASE (LO-GATE TO TOUCHDOWN) - MANUAL CONTROL TAKEOVER

PERATIONAL PHASES OF POWERED DESCENT

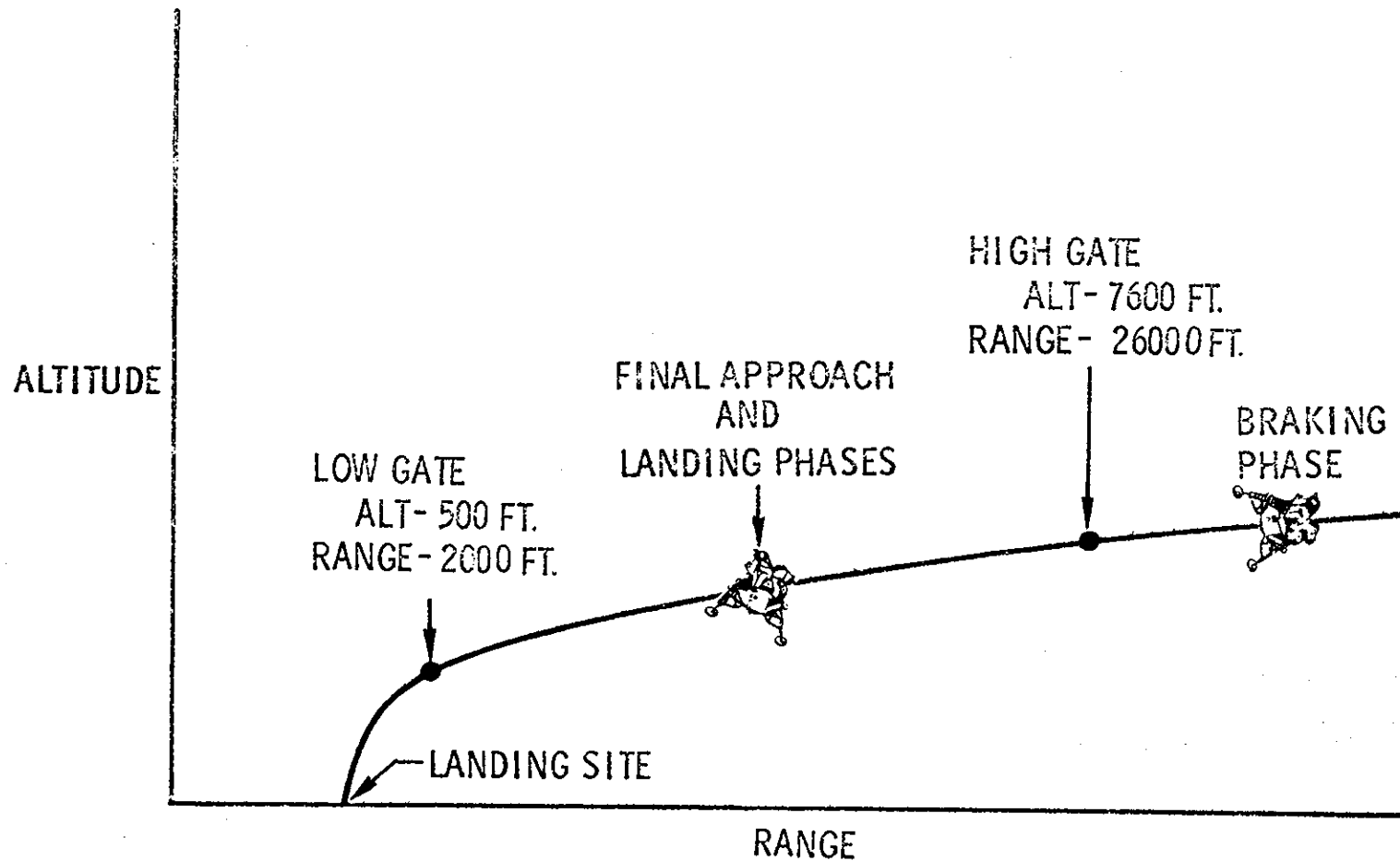

TARGET SEQUENCE FOR AUTOMATIC GUIDANCE

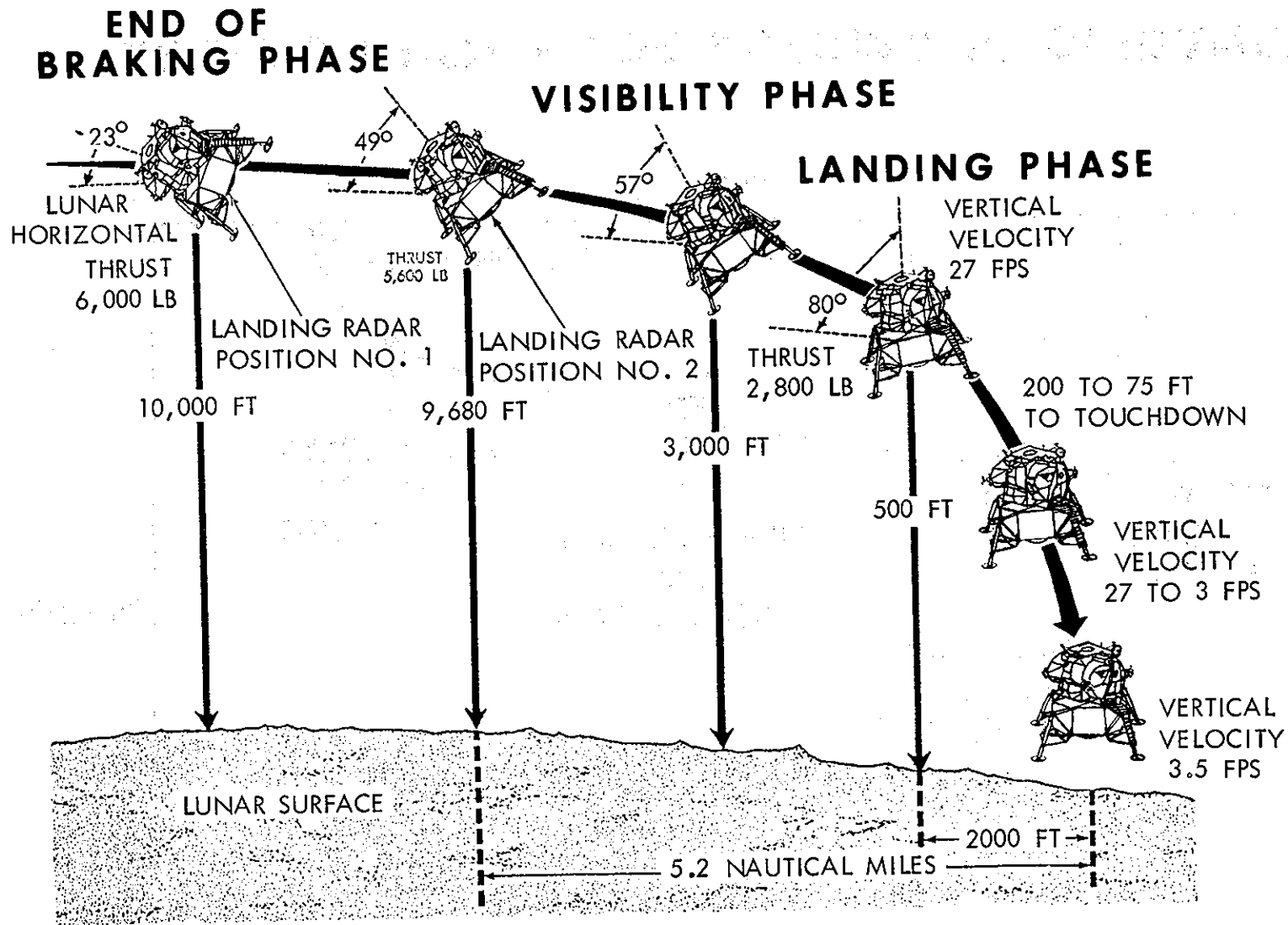

-more-

-40-

**NOMINAL DESCENT TRAJECTORY
FROM HIGH GATE TO TOUCHDOWN**

-more-

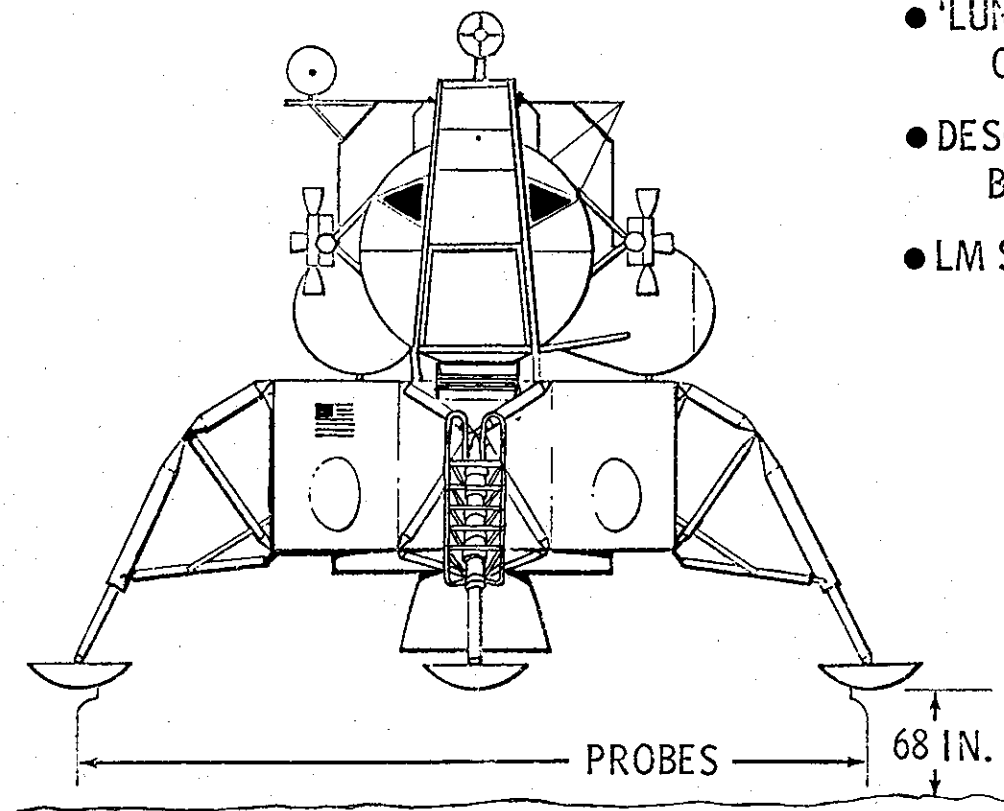

- PROBE CONTACTS LUNAR SURFACE
- 'LUNAR CONTACT' INDICATOR ON CONTROL PANEL LIGHTS
- DESCENT ENGINE IS SHUT DOWN BY CREW AFTER 1 SECOND
- LM SETTLES TO LUNAR SURFACE

-41-

LUNAR CONTACT SEQUENCE

Lunar Surface Extravehicular Activity (EVA)

Armstrong and Aldrin will spend about 22 hours on the lunar surface after lunar module touchdown at 102:47:11 GET. Following extensive checkout of LM systems and preparations for contingency ascent staging, the LM crew will eat and rest before depressurizing the LM for lunar surface EVA. Both crewmen will don portable life support system (PLSS) backpacks with oxygen purge system units (OPS) attached.

LM depressurization is scheduled for 112:30 GET with the commander being the first to egress the LM and step onto the lunar surface. His movements will be recorded on still and motion picture film by the lunar module pilot and by TV deployed by the commander prior to descending the ladder. The LM pilot will leave the LM about 25 minutes after the commander and both crewmen will collect samples of lunar material and deploy the Early Apollo Scientific Experiments Package (EASEP) and the solar wind composition (SWC) experiment.

The commander, shortly after setting foot on the lunar surface, will collect a contingency sample of surface material and place it in his suit pocket. Later both crewmen will collect as much as 130 pounds of loose materials and core samples which will be stowed in air-tight sample return containers for return to Earth.

Prior to sealing the SRC, the SWC experiment, which measures the elemental and isotopic constituents of the noble (inert) gases in the solar wind, is rolled up and placed in the container for return to Earth for analysis. Principal experimenter is Dr. Johannes Geiss, University of Bern, Switzerland.

The crew will photograph the landing site terrain and inspect the LM during the EVA. They can range out to about 100 feet from the LM.

After both crewmen have ingressed the LM and have connected to the cabin suit circuit, they will doff the PLSS backpacks and jettison them along with other gear no longer needed, through the LM front hatch onto the lunar surface.

The LM cabin will be repressurized about 2 hrs. 40 min. after EVA initiation to permit transfer by the crew to the LM life support systems. The LM will then be depressurized to jettison unnecessary equipment to the lunar surface and be repressurized. The crew will have a meal and rest period before preparing for ascent into lunar orbit and rendezvousing with the CSM.

TOUCHDOWN

LIFTOFF

POST- LAND C/O 2:04	EAT 0:35	1ST REST PERIOD 4:00	EAT 1:00	EVA PREP 2:00	EVA 2:40 0:25-CDR 2:15-BOTH	POST- EVA C/O 1:30	EAT 0:40	2ND REST PERIOD 4:40	ASC. PREP AND EAT 2:28
------------------------------	-------------	----------------------------	-------------	---------------------	--------------------------------------	-----------------------------	-------------	----------------------------	------------------------------

21:27 TOTAL TIME

-more-

-43-

LUNAR SURFACE ACTIVITY SCHEDULE

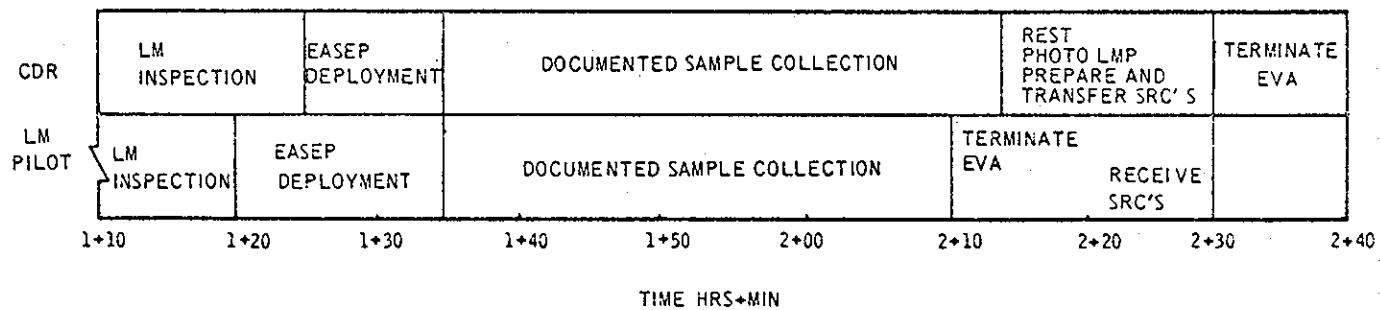
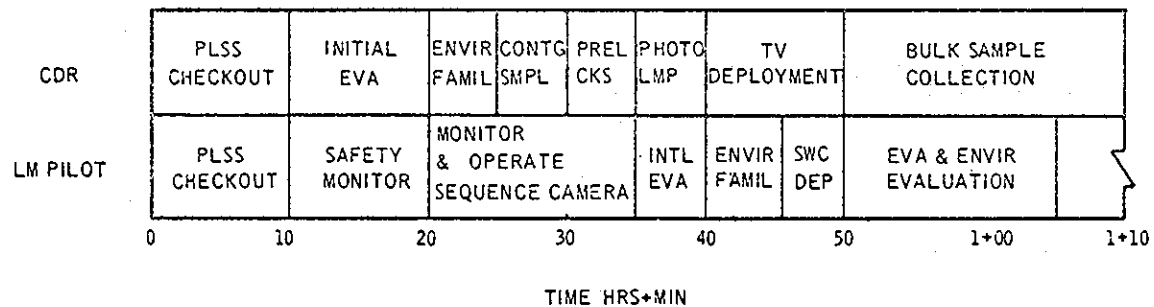

NOMINAL EVA TIMELINE

VIEW THRU OPTICAL CENTER OF TV LENS IN DIRECTION OF "Z"-PLANE

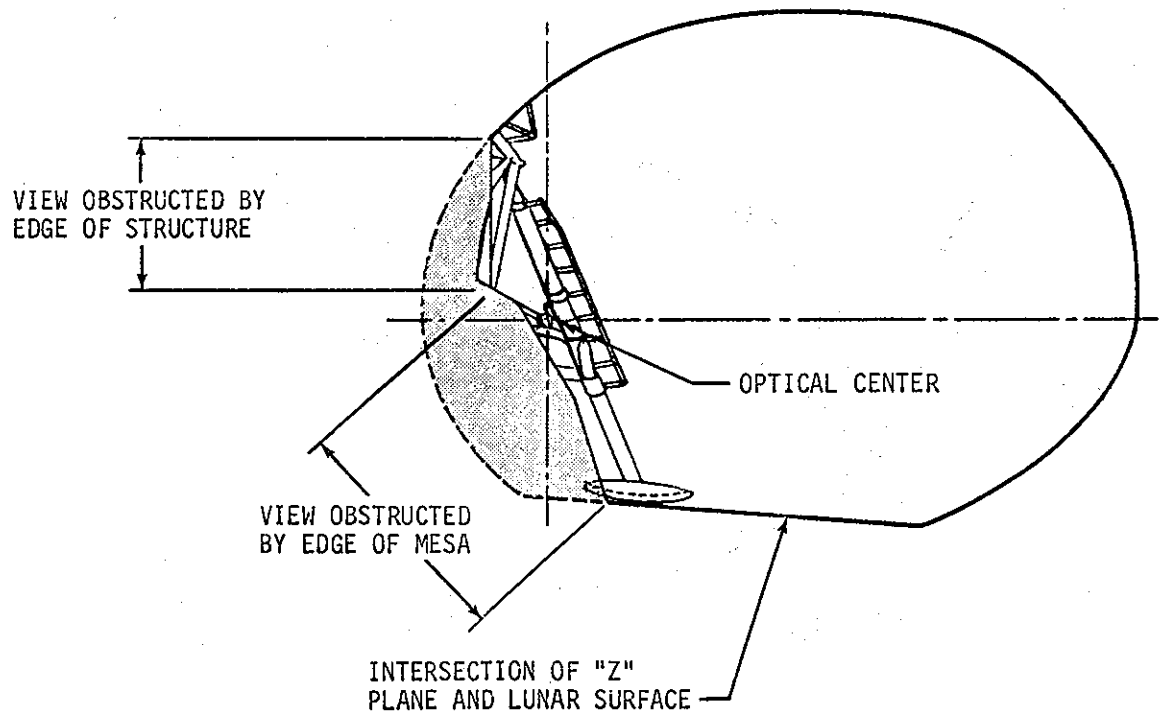

-more-

-45-

LUNAR SURFACE PHASE

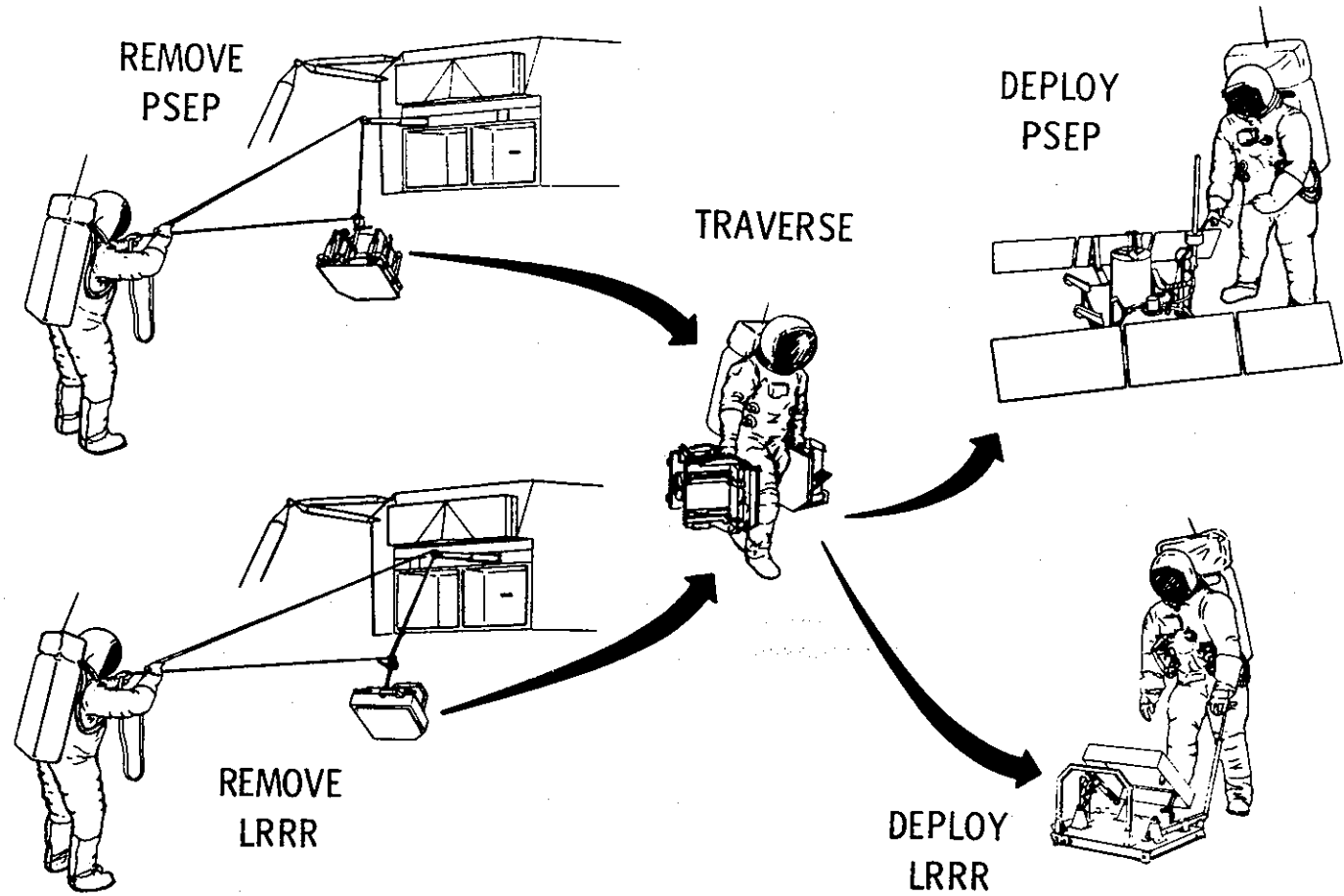

-more-

-46-

KEY:

SWC - SOLAR WIND COMPOSITION

LR3 - LASER RANGING RETRO REFLECTOR

PSE - PASSIVE SEISMIC EXPERIMENT

TV CAMERA
TRIPOD POSITION
(30 FT. FROM LM)

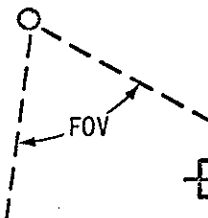

SWC POSITION
(FEW FEET FROM LM)

BULK SAMPLE
(NEAR MESA IN QUAD IV)

CONTINGENCY SAMPLE
(NEAR LADDER)

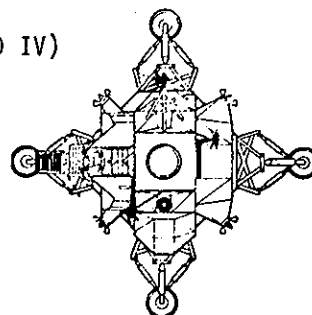

DOCUMENTED SAMPLE
(WITHIN 100 FT. FROM LM)

LR 3 POSITION
(70 FT. FROM LM)

PSE POSITION
(80 FT. FROM LM)

-more-

-47-

Lunar Sample Collection

Equipment for collecting and stowing lunar surface samples is housed in the modularized equipment stowage assembly (MESA) on the LM descent stage. The commander will unstow the equipment after adjusting to the lunar surface environment.

Items stowed in the MESA are as follows:

- * Black and white TV camera.
- * Large scoop for collecting bulk and documented samples of loose lunar surface material.
- * Extension handle that fits the large scoop, core tubes and hammer.
- * Tongs for collecting samples of rock and for picking up dropped tools.
- * Gnomon for vertical reference, color and dimension scale for lunar surface photography.
- * Hammer for driving core tubes, chipping rock and for trenching (with extension handle attached).
- * 35mm stereo camera.
- * Two sample return containers (SRC) for returning up to 130 pounds of bulk and documented lunar samples. Items such as large and small sample bags, core tubes, gas analysis and lunar environment sample containers are stowed in the SRCs. Both containers are sealed after samples have been collected, documented and stowed, and the crew will hoist them into the ascent stage by means of an equipment conveyor for transfer into the command module and subsequent return to Earth for analysis in the Lunar Receiving Laboratory.

Additionally, a contingency lunar sample return container is stowed in the LM cabin for use by the commander during the early phases of his EVA. The device is a bag attached to an extending handle in which the commander will scoop up about one liter of lunar material. He then will jettison the handle and stow the contingency sample in his pressure suit pocket.

LM Ascent, Lunar Orbit Rendezvous

Following the 22-hour lunar stay time during which the commander and lunar module pilot will deploy the Early Apollo Scientific Experiments Package (EASEP), the Solar Wind Composition (SWC) experiment, and gather lunar soil samples, the LM ascent stage will lift off the lunar surface to begin the rendezvous sequence with the orbiting CSM. Ignition of the LM ascent engine will be at 124:23:21 for a 7 min 14 sec burn with a total velocity of 6,055 fps. Powered ascent is in two phases: vertical ascent for terrain clearance and the orbital insertion phase. Pitchover along the desired launch azimuth begins as the vertical ascent rate reached 50 fps about 10 seconds after liftoff at about 250 feet in altitude. Insertion into a 9 x 45-nm lunar orbit will take place about 166 nm west of the landing site.

Following LM insertion into lunar orbit, the LM crew will compute onboard the four major maneuvers for rendezvous with the CSM which is about 255 nm ahead of the LM at this point. All maneuvers in the sequence will be made with the LM RCS thrusters. The premission rendezvous sequence maneuvers, times and velocities which likely will differ slightly in real time, are as follows:

-more-

LM ASCENT

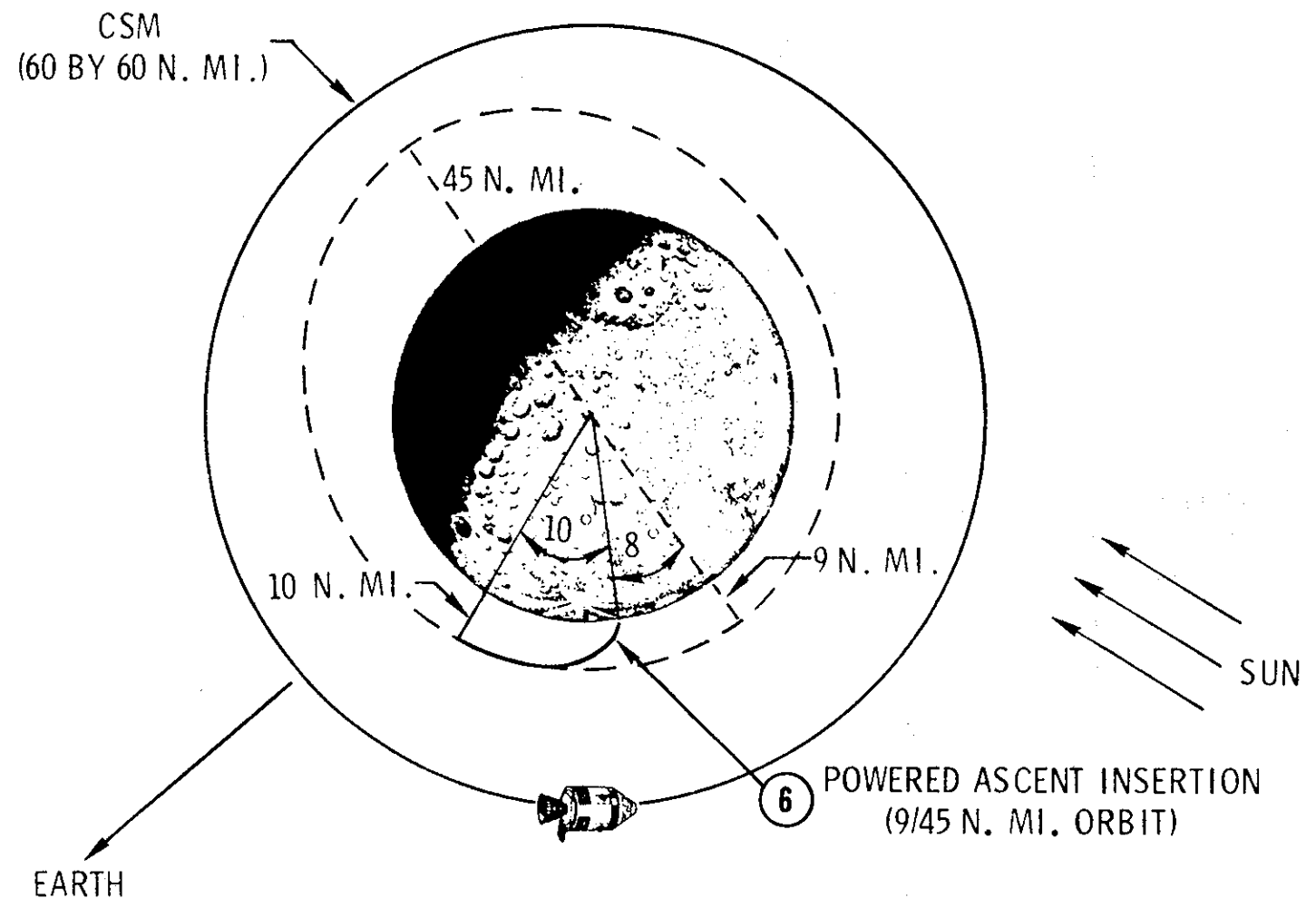

-more-

-50-

-more-

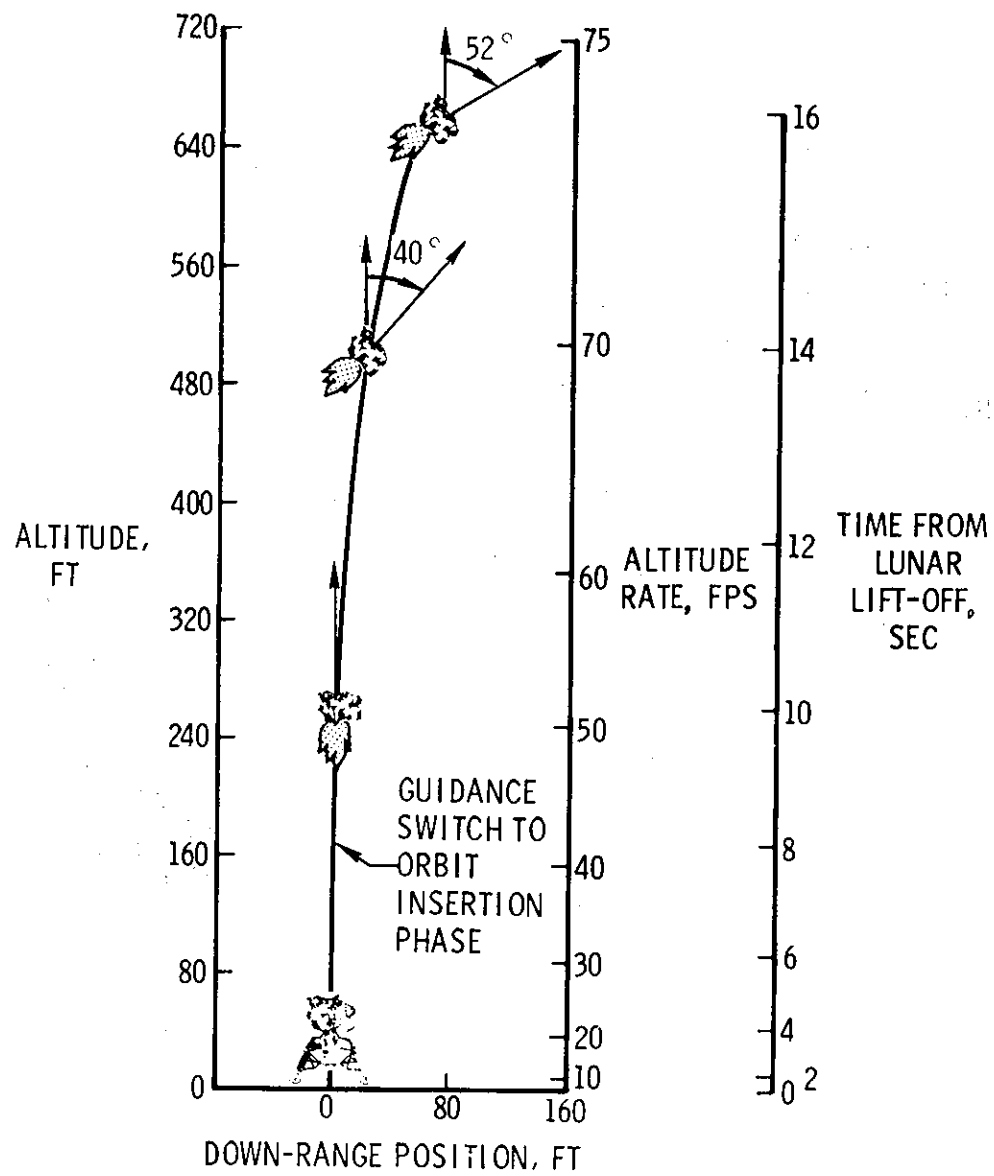

-51-

VERTICAL RISE PHASE

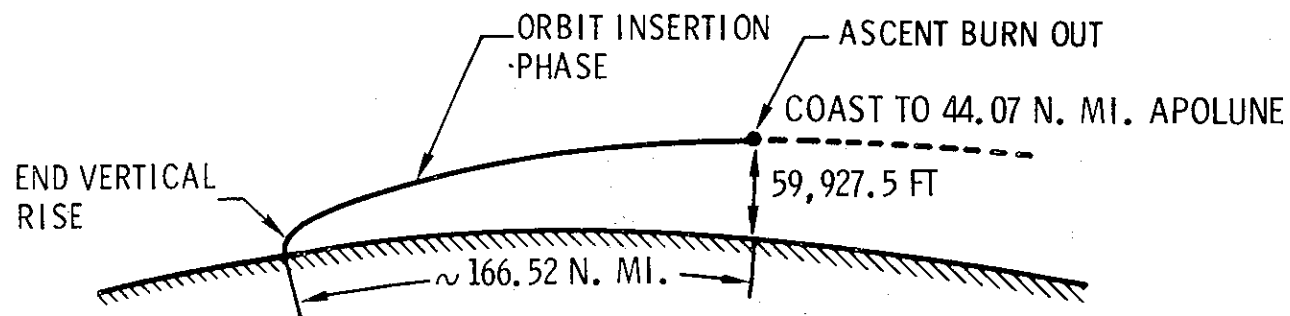

TOTAL ASCENT:
 BURN TIME = 7:14.65 MIN:SEC
 ΔV REQUIRED = 6,055.39 FPS
 PROPELLANT REQUIRED = 4,989.86 LB

INSERTION ORBIT PARAMETERS

$h_p = 55,905.4$ FT
 $h_a = 44.07$ N. MI.
 $\eta = 17.59^\circ$
 $\gamma = .324$

ONBOARD DISPLAYS AT INSERTION

$V = 5,535.9$ FPS
 $h = 32.2$ FPS
 $h = 60,129.5$ FT

ORBIT INSERTION PHASE

Concentric sequence initiate (CSI): At first LM apolune after insertion 125:21:20 GET, 49 fps posigrade, following some 20 minutes of LM rendezvous radar tracking and CSM sextant/VHF ranging navigation. CSI will be targeted to place the LM in an orbit 15 nm below the CSM at the time of the later constant delta height (CDH) maneuver. The CSI burn may also initiate corrections for any out-of-plane dispersions resulting from insertion azimuth errors. Resulting LM orbit after CSI will be 45.5 x 44.2 nm and will have a catchup rate to the CSM of .072 degrees per minute.

Another plane correction is possible about 29 minutes after CSI at the nodal crossing of the CSM and LM orbits to place both vehicles at a common node at the time of the CDH maneuver at 126:19:40 GET.

Terminal phase initiate (TPI): This maneuver occurs at 126:58:26 and adds 24.6 fps along the line of sight toward the CSM when the elevation angle to the CSM reaches 26.6 degrees. The LM orbit becomes 61.2 x 43.2 nm and the catchup rate to the CSM decreases to .032 degrees per second, or a closing rate of 131 fps.

Two midcourse correction maneuvers will be made if needed, followed by four braking maneuvers at: 127:39:43 GET, 11.5 fps; 127:40:56, 9.8 fps; 127:42:35 GET, 4.8 fps; and at 127:43:54 GET, 4.7 fps. Docking nominally will take place at 128 hrs GET to end three and one-half hours of the rendezvous sequence.

Transearth Injection (TEI)

The LM ascent stage will be jettisoned about four hours after hard docking and the CSM will make a 1 fps retrograde separation maneuver.

The nominal transearth injection burn will be at 135:24 GET following 59.5 hours in lunar orbit. TEI will take place on the lunar farside and will be a 3,293 fps posigrade SPS burn of 2 min 29 sec duration and will produce an entry velocity of 36,194 fps after a 59.6 hr transearth flight time.

An optional TEI plan for five revolutions later would allow a crew rest period before making the maneuver. TEI ignition under the optional plan would take place at 145:23:45 GET with a 3,698 fps posigrade SPS burn producing an entry velocity of 36,296 fps and a transearth flight time of 51.8 hrs.

LUNAR MODULE CONCENTRIC SEQUENCE INITIATION MANEUVER

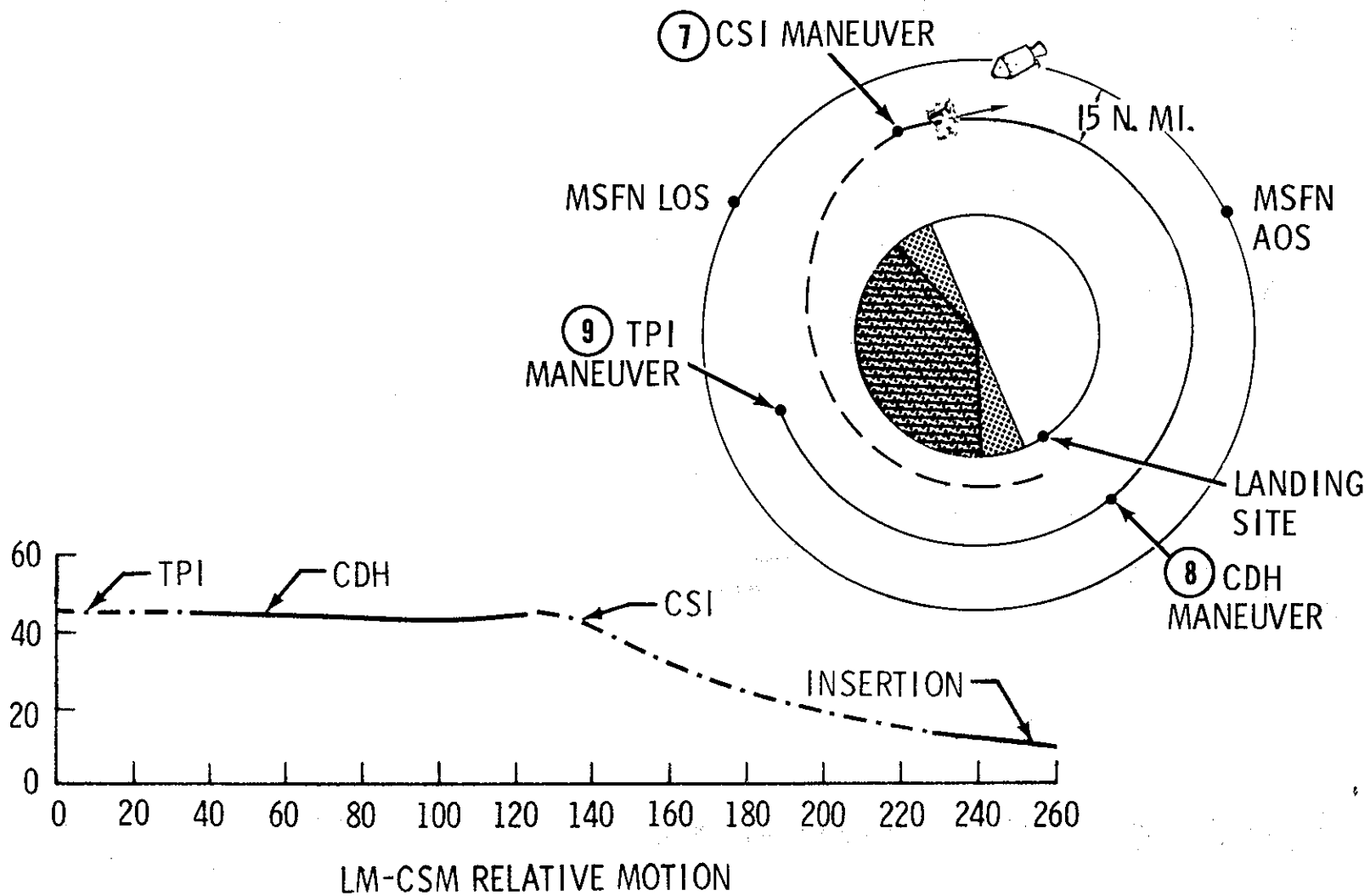

LUNAR MODULE CONSTANT DIFFERENTIAL HEIGHT AND TERMINAL PHASE MANEUVERS

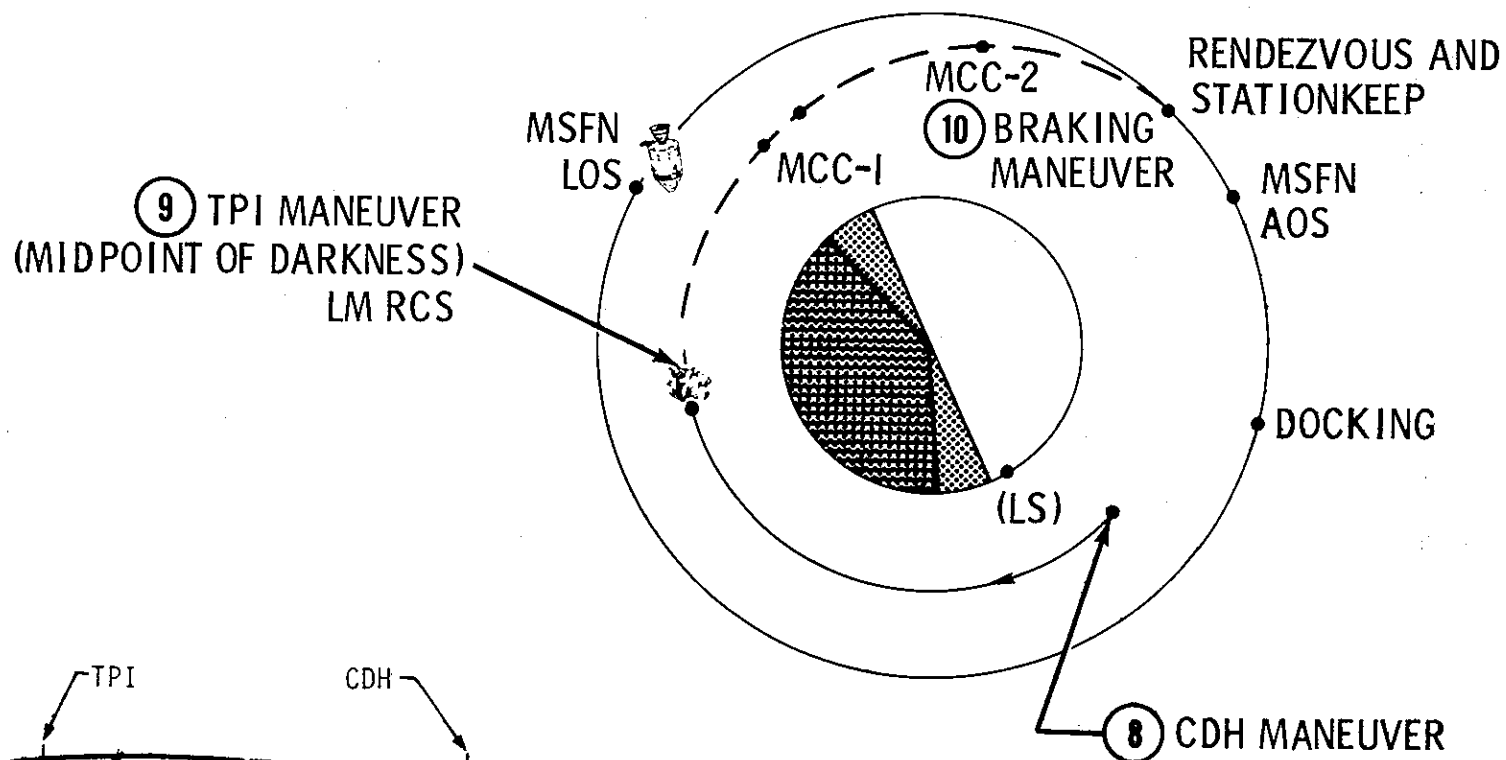

VERTICAL
DISPLACEMENT
(N MI)

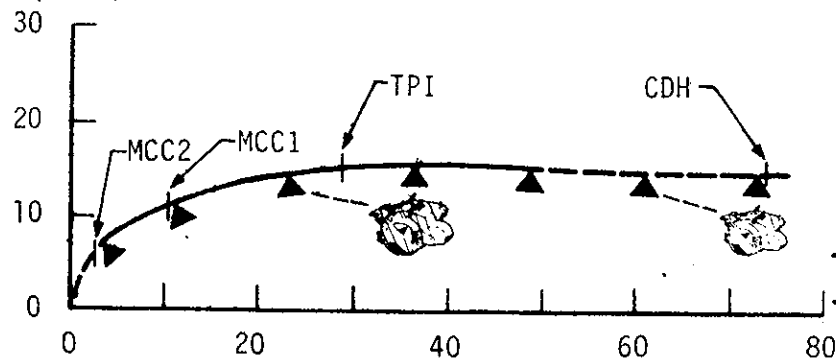

TRAILING DISPLACEMENT (N MI)

LM-CSM RELATIVE MOTION

TRANSEARTH INJECTION

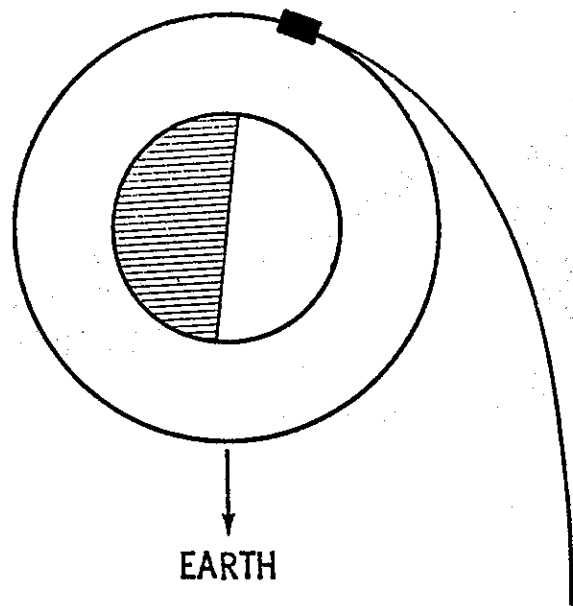

G. E. T. IGN

ΔV

BURN TIME

135^H 23^M

3294 F P S

2^M 29^S

-more-

Transearch coast

Three corridor-control transearch midcourse correction burns will be made if needed: MCC-5 at TEI +15 hrs, MCC-6 at entry interface (EI=400,000 feet) -15 hrs and MCC-7 at EI -3 hrs.

Entry, Landing

Apollo 11 will encounter the Earth's atmosphere (400,000 feet) at 195:05:04 GET at a velocity of 36,194 fps and will land some 1,285 nm downrange from the entry-interface point using the spacecraft's lifting characteristics to reach the landing point. Touch-down will be at 195:19:05 at 10.6 degrees north latitude by 172.4 west longitude.

EARTH ENTRY

- ENTRY RANGE CAPABILITY - 1200 TO 2500 N. MI.
- NOMINAL ENTRY RANGE - 1285 N. MI.
- SHORT RANGE SELECTED FOR NOMINAL MISSION BECAUSE:
 - RANGE FROM ENTRY TO LANDING CAN BE SAME FOR PRIMARY AND BACKUP CONTROL MODES
 - PRIMARY MODE EASIER TO MONITOR WITH SHORT RANGE
- WEATHER AVOIDANCE, WITHIN ONE DAY PRIOR TO ENTRY, IS ACHIEVED USING ENTRY RANGING CAPABILITY TO 2500 N. MI.
- UP TO ONE DAY PRIOR TO ENTRY USE PROPULSION SYSTEM TO CHANGE LANDING POINT

-more-

-58-

-more-

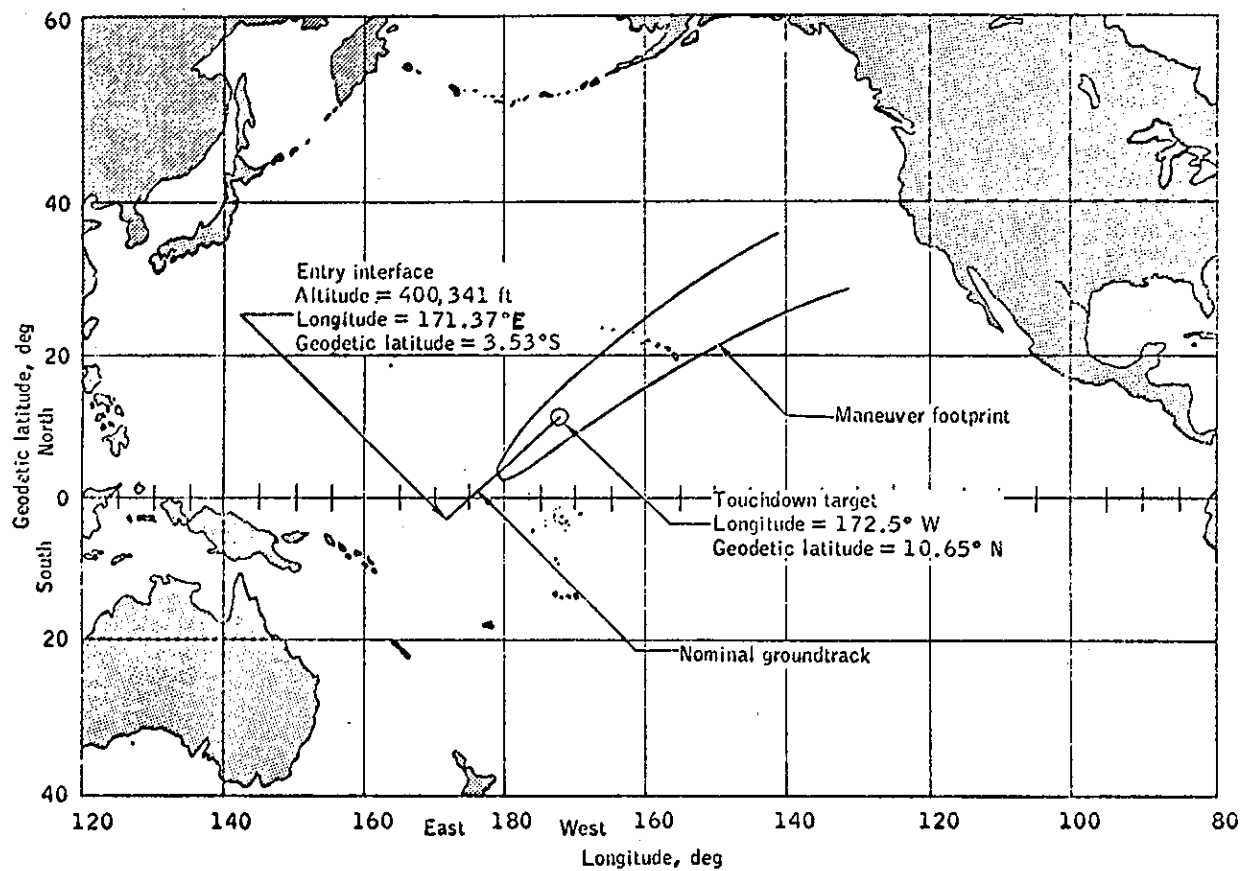

-59-

MANEUVER FOOTPRINT AND NOMINAL GROUNDTRACK

GEODETIC ALTITUDE VERSUS RANGE TO GO

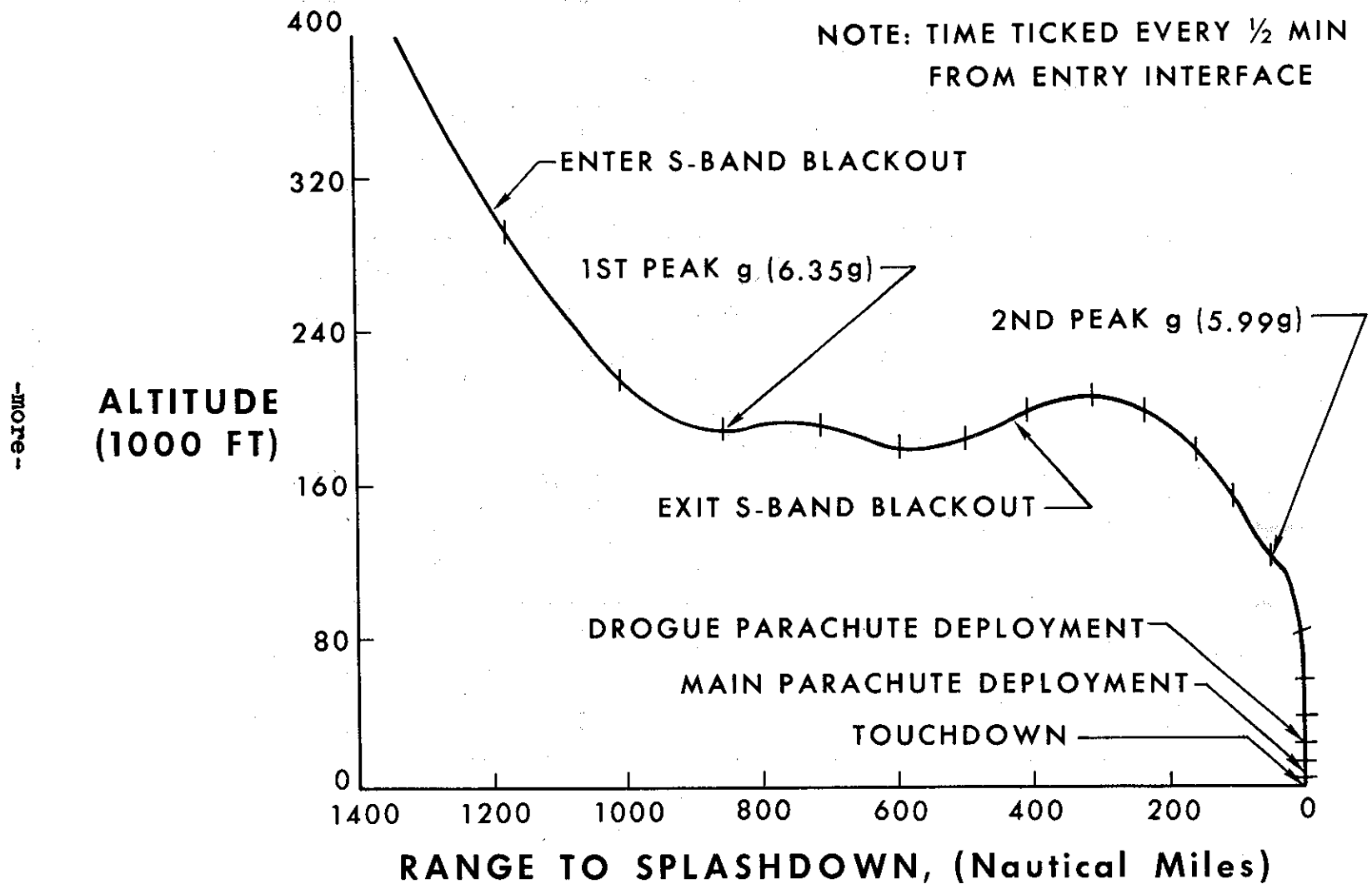

--MORE--

-69-

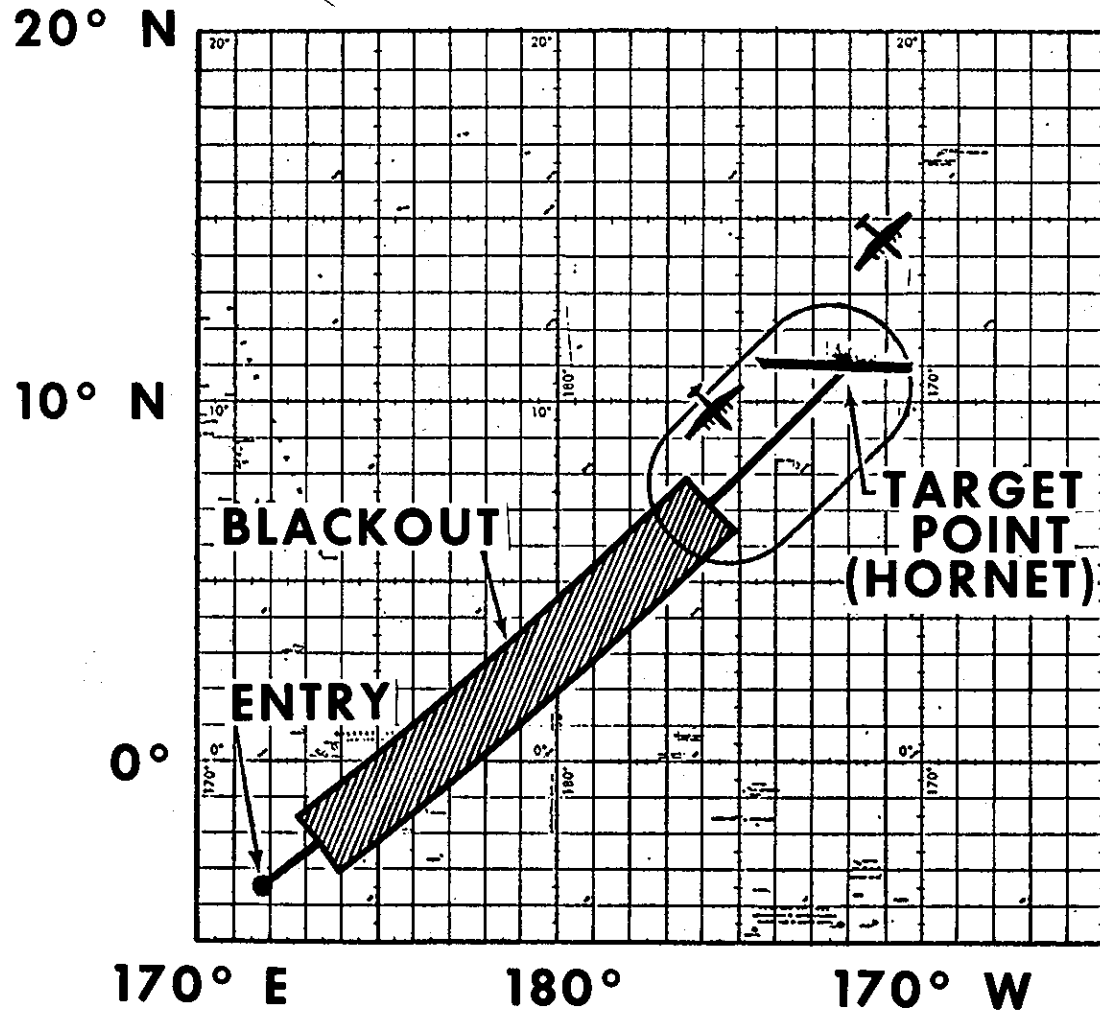

PRIMARY LANDING AREA

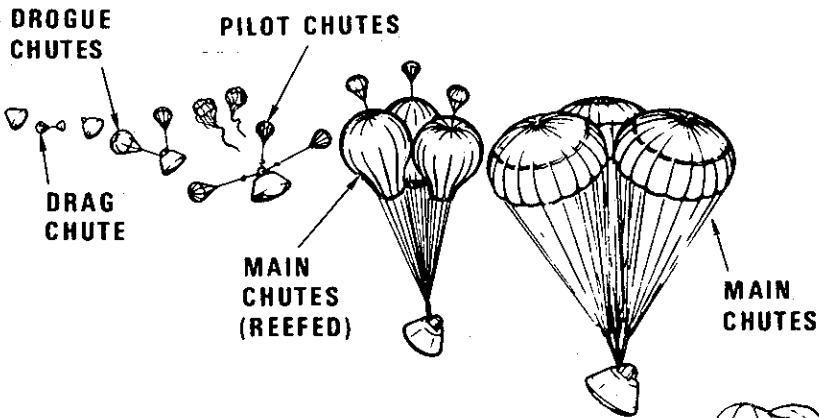
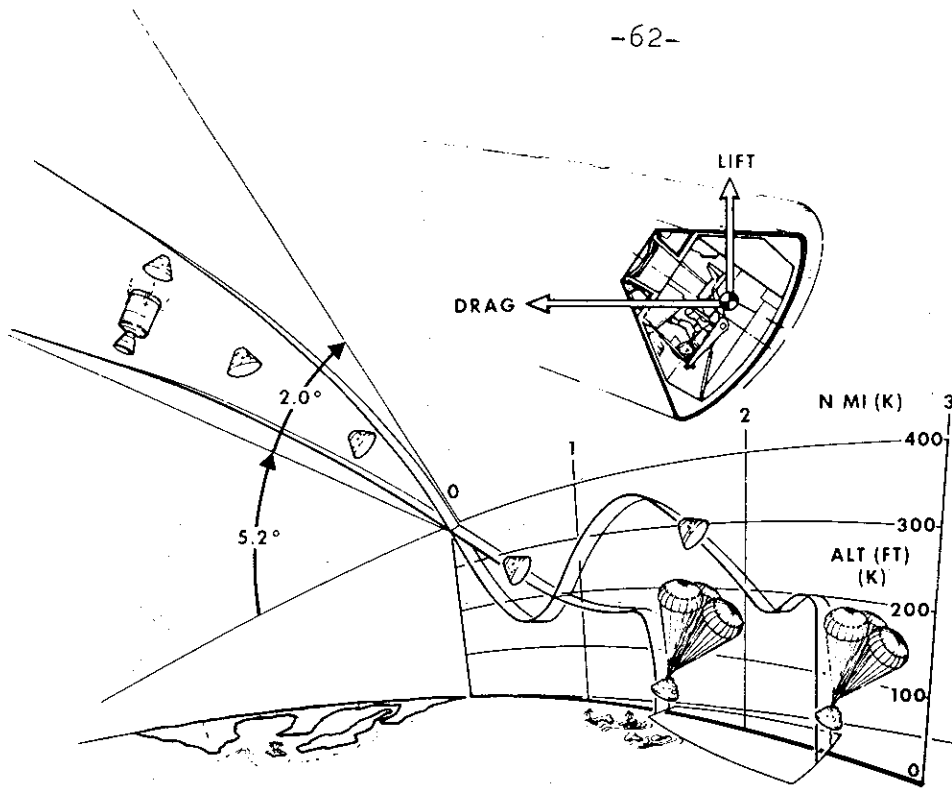

SPLASH DOWN VELOCITIES:

3 CHUTES - 31 FT/SEC
2 CHUTES - 36 FT/ SEC

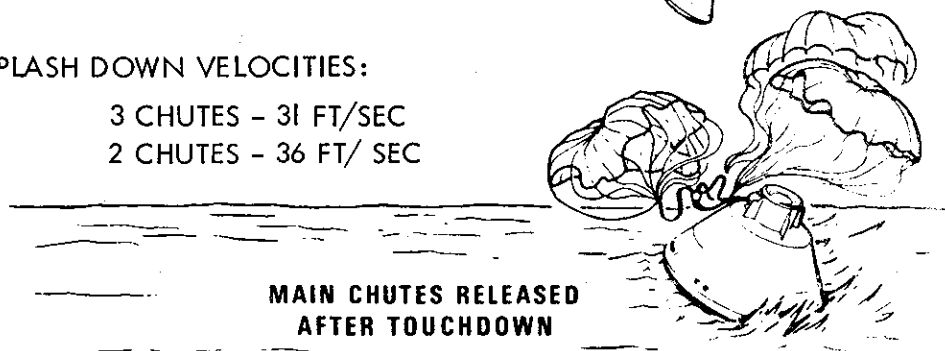

EARTH RE-ENTRY AND LANDING

-more-

LAUNCH DATE
JULY 1969

LANDING DATE
JULY 1969

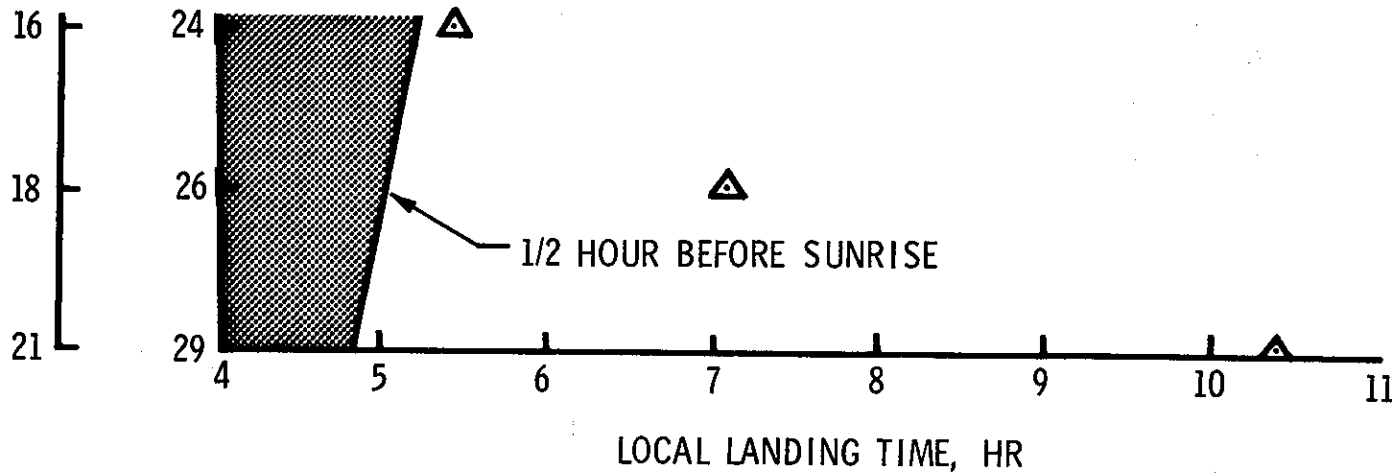

LOCAL LANDING TIMES

-more-

-63-

RECOVERY OPERATIONS, QUARANTINE

The prime recovery line for Apollo 11 is the mid-Pacific along the 175th west meridian of longitude above 15 degrees north latitude, and jogging to 165 degrees west longitude below the equator. The aircraft carrier USS Hornet, Apollo 11 prime recovery ship, will be stationed near the end-of-mission aiming point prior to entry.

Splashdown for a full-duration lunar landing mission launched on time July 16 will be at 10.6 degrees north by 172.5 degrees west at a ground elapsed time of 195 hrs 15 min.

The latitude of splashdown depends upon the time of the transearth injection burn and the declination of the Moon at the time of the burn. A spacecraft returning from a lunar mission will enter the Earth's atmosphere and splash down at a point on the Earth's farside directly opposite the Moon. This point, called the antipode, is a projection of a line from the center of the Moon through the center of the Earth to the surface opposite the Moon. The mid-Pacific recovery line rotates through the antipode once each 24 hours, and the transearth injection burn will be targeted for splashdown along the primary recovery line.

Other planned recovery lines for lunar missions are the East Pacific line extending roughly parallel to the coastlines of North and South America; the Atlantic Ocean line running along the 30th west meridian in the northern hemisphere and along the 25th west meridian in the southern hemisphere, and the Indian Ocean along the 65th east meridian.

Secondary landing areas for a possible Earth orbital alternate mission are in three zones---one in the Pacific and two in the Atlantic.

Launch abort landing areas extend downrange 3,200 nautical miles from Kennedy Space Center, fanwise 50 nm above and below the limits of the variable launch azimuth (72-106 degrees). Ships on station in the launch abort area will be the destroyer USS New, the insertion tracking ship USNS Vanguard and the minesweeper-countermeasures ship USS Ozark.

In addition to the primary recovery ship located on the mid-Pacific recovery line and surface vessels on the Atlantic Ocean recovery line and in the launch abort area, 13 HC-130 aircraft will be on standby at seven staging bases around the Earth: Guam; Hawaii; Bermuda; Lajes, Azores; Ascension Island; Mauritius and the Panama Canal Zone.

Apollo 11 recovery operations will be directed from the Recovery Operations Control Room in the Mission Control Center and will be supported by the Atlantic Recovery Control Center, Norfolk, Va., and the Pacific Recovery Control Center, Kunia, Hawaii.

After splashdown, the Apollo 11 crew will don biological isolation garments passed to them through the spacecraft hatch by a recovery swimmer. The crew will be carried by helicopter to the Hornet where they will enter a Mobile Quarantine Facility (MQF) about 90 minutes after landing. The MQF, with crew aboard, will be offloaded at Ford Island, Hawaii and loaded on a C-141 aircraft for the flight to Ellington AFB, Texas, and thence trucked to the Lunar Receiving Laboratory (LRL).

The crew will arrive at the LRL on July 27 following a nominal lunar landing mission and will go into the LRL Crew Reception area for a total of 21 days quarantine starting from the time they lifted off the lunar surface. The command module will arrive at the LRL two or three days later to undergo a similar quarantine. Lunar material samples will undergo a concurrent analysis in the LRL Sample Operations area during the quarantine period.

Lunar Receiving Laboratory

The Manned Spacecraft Center Lunar Receiving Laboratory has as its main function the quarantine and testing of lunar samples, spacecraft and flight crews for possible harmful organisms brought back from the lunar surface.

Detailed analysis of returned lunar samples will be done in two phases---time-critical investigations within the quarantine period and post-quarantine scientific studies of lunar samples repackaged and distributed to participating scientists.

There are 36 scientists and scientific groups selected in open world-wide competition on the scientific merits of their proposed experiments. They represent some 20 institutions in Australia, Belgium, Canada, Finland, Federal Republic of Germany, Japan, Switzerland and the United Kingdom. Major fields of investigation will be mineralogy and petrology, chemical and isotope analysis, physical properties, and biochemical and organic analysis.

The crew reception area serves as quarters for the flight crew and attendant technicians for the quarantine period in which the pilots will be debriefed and examined. The other crew reception area occupants are physicians, medical technicians, housekeepers and cooks. The CRA is also a contingency quarantine area for sample operations area people exposed to spills or vacuum system breaks.

Both the crew reception area and the sample operations area are contained within biological barrier systems that protect lunar materials from Earth contamination as well as protect the outside world from possible contamination by lunar materials.



BIOLOGICAL ISOLATION GARMENT

Analysis of lunar samples will be done in the sample operations area, and will include vacuum, magnetics, gas analysis, biological test, radiation counting and physical-chemical test laboratories.

Lunar sample return containers, or "rock boxes", will first be brought to the vacuum laboratory and opened in the ultra-clean vacuum system. After preliminary examination, the samples will be repackaged for transfer, still under vacuum, to the gas analysis, biological preparation, physical-chemical test and radiation counting laboratories.

The gas analysis lab will measure amounts and types of gases produced by lunar samples, and geochemists in the physical-chemical test lab will test the samples for their reactions to atmospheric gases and water vapor. Additionally, the physical-chemical test lab will make detailed studies of the mineralogic, petrologic, geochemical and physical properties of the samples.

Other portions of lunar samples will travel through the LRL vacuum system to the biological test lab where they will undergo tests to determine if there is life in the material that may replicate. These tests will involve introduction of lunar samples into small germ-free animals and plants. The biological test laboratory is made up of several smaller labs---bioprep, bio-analysis, germ-free, histology, normal animals (amphibia and invertebrates), incubation, anaerobic and tissue culture, crew microbiology and plants.

Some 50 feet below the LRL ground floor, the radiation counting lab will conduct low-background radioactive assay of lunar samples using gamma ray spectrometry techniques.

(See Contamination Control Program section for more details on LRL, BIGs, and the Mobile Quarantine Facility.)

SCHEDULE FOR TRANSPORT OF SAMPLES, SPACECRAFT, CREW

Samples

Two helicopters will carry lunar samples from the recovery ship to Johnston Island where they will be put aboard a C-141 and flown directly to Houston and the Lunar Receiving Laboratory (LRL). The samples should arrive at Ellington Air Force Base at about 27 hours after recovery and received in the LRL at about 9 or 10 a.m. CDT, July 25.

Spacecraft

The spacecraft is scheduled to be brought aboard the recovery ship about two hours after recovery. About 55 hours after recovery the ship is expected to arrive in Hawaii. The spacecraft will be deactivated in Hawaii (Ford Island) between 55 and 127 hours after recovery. At 130 hours it is scheduled to be loaded on a C-133 for return to Ellington AFB. Estimated time of arrival at the LRL is on July 29, 140 hours after recovery.

Crew

The flight crew is expected to enter the Mobile Quarantine Facility (MQF) on the recovery ship about 90 minutes after splash-down. The ship is expected to arrive in Hawaii at recovery plus 55 hours and the Mobile Quarantine Facility will be transferred to a C-141 aircraft at recovery plus 57 hours. The aircraft will land at Ellington AFB at recovery plus 65 hours and the MQF will arrive at the LRL about two hours later (July 27).

-more-

LUNAR RECEIVING LABORATORY PROCEDURES TIMELINE (TENTATIVE)

Sample Operations Area (SOAO)

Arrival LRL	Event	Location
Arrival	Sample containers arrive crew reception area, outer covering checked, tapes and films removed	Crew reception area
Arrival	Container #1 introduced into system	Vacuum chamber lab
	Containers weighed	" " "
	Transfer contingency sample to F-25a chamber for examination after containers #1 and #2	" " "
	Containers sterilized, dried in atmospheric decontamination and passed into glove chamber F201	" " "
	Residual gas analyzed (from containers)	" " "
" plus 5 hours	Open containers	" " "
	Weigh, preliminary exam of samples and first visual inspection by preliminary evaluation team	" " "
" plus 8 hours	Remove samples to Radiation Counting, Gas Analysis Lab & Mineralogy & Petrology Lab	Vacuum chamber lab RCL-Basement Min-Pet 1st floor
" plus 13 hours	Preliminary information Radiation counting. Transfer container #1 out of chamber	Vacuum chamber lab
	Initial detailed exam by Preliminary Evaluation Team Members	" " "
	Sterile sample to Bio prep (100 gms) (24 to 48 hr preparation for analysis)	Bio Test area - 1st floor
	Monopole experiment	Vacuum chamber lab

<u>Arrival LRL</u>	<u>Event</u>	<u>Location</u>
" plus 13 hours	Transfer samples to Phys-Chem Lab Detailed photography of samples and microscopic work	Phys-Chem - 1st floor Vacuum chamber lab
" plus 24 hours	All samples canned and remain in chamber	" " "
" plus 1-2 days	Preparations of samples in bioprep lab for distribution to bio test labs. (Bacteriology, Virology, Germ-free mice) through TEI plus 21 days	Bio test labs - 1st floor
" plus 4-5 days	Early release of phys-chem analy- sis	Phys-Chem labs - 1st floor
" plus about 7 - 15 days	Detailed bio analysis & further phys-chem analysis	Bio test & min-pet 1st floor
" plus 15 days	Conventional samples transferred to bio test area (24-48 hours preparation for analysis)	1st floor
" plus 17 days	Bio test begins on additional bacteriological, virological, microbiological invertebrates, (fish, shrimp, oysters), birds, mice, lower invertebrates (house- fly, moth, german cockroach, etc), plants (about 20) (through approximately arrival plus 30 days)	1st floor
" plus 30 days	Bio test info released on pre- liminary findings	1st floor
	Samples go to thin section lab (first time outside barrier) for preparation and shipment to principal investigators	1st floor

APOLLO 11 GO/NO-GO DECISION POINTS

Like Apollo 8 and 10, Apollo 11 will be flown on a step-by-step commit point or go/no-go basis in which the decisions will be made prior to each maneuver whether to continue the mission or to switch to one of the possible alternate missions. The go/no-go decisions will be made by the flight control teams in Mission Control Center jointly with the flight crew.

Go/no-go decisions will be made prior to the following events:

- * Launch phase go/no-go at 10 min GET for orbit insertion
- * Translunar injection
- * Transposition, docking and LM extraction
- * Each translunar midcourse correction burn
- * Lunar orbit insertion burns Nos. 1 and 2
- * CSM-LM undocking and separation
- * LM descent orbit insertion
- * LM powered descent initiation
- * LM landing
- * Periodic go/no-gos during lunar stay
- * Lunar surface extravehicular activity
- * LM ascent and rendezvous (A no-go would delay ascent one revolution)
- * Transearth injection burn (no-go would delay TEI one or more revolutions to allow maneuver preparations to be completed)
- * Each transearth midcourse correction burn.

APOLLO 11 ALTERNATE MISSIONS

Six Apollo 11 alternate missions, each aimed toward meeting the maximum number of mission objectives and gaining maximum Apollo systems experience, have been evolved for real-time choice by the mission director. The alternate missions are summarized as follows:

Alternate 1 - S-IVB fails prior to Earth orbit insertion: CSM only contingency orbit insertion (COI) with service propulsion system. The mission in Earth orbit would follow the lunar mission timeline as closely as possible and would include SPS burns similar in duration to LOI and TEI, while at the same time retaining an RCS deorbit capability. Landing would be targeted as closely as possible to the original aiming point.

Alternate 2 - S-IVB fails to restart for TLI: CSM would dock with and extract the LM as soon as possible and perform an Earth orbit mission, including docked DPS burns and possibly CSM-active rendezvous along the lunar mission timeline, with landing at the original aiming point. Failure to extract the LM would result in an Alternate 1 type mission.

Alternate 3 - No-go for nominal TLI because of orbital conditions or insufficient S-IVB propellants: TLI retargeted for lunar mission if possible; if not possible, Alternate 2 would be followed. The S-IVB would be restarted for a high-ellipse injection provided an apogee greater than 35,000 nm could be achieved. If propellants available in the S-IVB were too low to reach the 35,000 nm apogee, the TLI burn would be targeted out of plane and an Earth orbit mission along the lunar mission timeline would be flown.

Depending upon the quantity of S-IVB propellant available for a TLI-type burn that would produce an apogee greater than 35,000 nm, Alternate 3 is broken down into four subalternates:

- Alternate 3A - Propellant insufficient to reach 35,000 nm
- Alternate 3B - Propellant sufficient to reach apogee between 35,000 and 65,000 nm
- Alternate 3C - Propellant sufficient to reach apogee between 65,000 and 200,000 nm
- Alternate 3D - Propellant sufficient to reach apogee of 200,000 nm or greater; this alternate would be a near-nominal TLI burn and midcourse correction burn No. 1 would be targeted to adjust to a free-return trajectory.

Alternate 4 - Non-nominal or early shutdown TLI burn: Real-time decision would be made on whether to attempt a lunar mission or an Earth orbit mission, depending upon when TLI cutoff occurs. A lunar mission would be possible if cutoff took place during the last 40 to 45 seconds of the TLI burn. Any alternate mission chosen would include adjusting the trajectory to fit one of the above listed alternates and touchdown at the nominal mid-Pacific target point.

Alternate 5 - Failure of LM to eject after transposition and docking: CSM would continue alone for a circumlunar or lunar orbit mission, depending upon spacecraft systems status.

Alternate 6 - LM systems failure in lunar orbit: Mission would be modified in real time to gain the maximum of LM systems experience within limits of crew safety and time. If the LM descent propulsion system operated normally, the LM would be retained for DPS backup transearth injection; if the DPS were no-go, the entire LM would be jettisoned prior to TEI.

ABORT MODES

The Apollo 11 mission can be aborted at any time during the launch phase or terminated during later phases after a successful insertion into Earth orbit.

Abort modes can be summarized as follows:

Launch phase --

Mode I - Launch escape system (LES) tower propels command module away from launch vehicle. This mode is in effect from about T-45 minutes when LES is armed until LES tower jettison at 3:07 GET and command module landing point can range from the Launch Complex 39A area to 400 nm downrange.

Mode II - Begins when LES tower is jettisoned and runs until the SPS can be used to insert the CSM into a safe Earth orbit (9:22 GET) or until landing points approach the African coast. Mode II requires manual separation, entry orientation and full-lift entry with landing between 350 and 3,200 nm downrange.

Mode III - Begins when full-lift landing point reached 3,200 nm (3,560 sm, 5,931 km) and extends through Earth orbital insertion. The CSM would separate from the launch vehicle, and if necessary, an SPS retrograde burn would be made, and the command module would be flown half-lift to entry and landing at approximately 3,350 nm (3,852 sm, 6,197 km) downrange.

Mode IV and Apogee Kick - Begins after the point the SPS could be used to insert the CSM into an Earth parking orbit -- from about 9:22 GET. The SPS burn into orbit would be made two minutes after separation from the S-IVB and the mission would continue as an Earth orbit alternate. Mode IV is preferred over Mode III. A variation of Mode IV is the apogee kick in which the SPS would be ignited at first apogee to raise perigee for a safe orbit.

Deep Space Aborts

Translunar Injection Phase --

Aborts during the translunar injection phase are only a remote possibility, but if an abort became necessary during the TLI maneuver, an SPS retrograde burn could be made to produce spacecraft entry. This mode of abort would be used only in the event of an extreme emergency that affected crew safety. The spacecraft landing point would vary with launch azimuth and length of the TLI burn. Another TLI abort situation would be used if a malfunction cropped up after injection. A retrograde SPS burn at about 90 minutes after TLI shutoff would allow targeting to land on the Atlantic Ocean recovery line.

-more-

Translunar Coast phase --

Aborts arising during the three-day translunar coast phase would be similar in nature to the 90-minute TLI abort. Aborts from deep space bring into the play the Moon's antipode (line projected from Moon's center through Earth's Center to the surface opposite the Moon) and the effect of the Earth's rotation upon the geographical location of the antipode. Abort times would be selected for landing when the 165 degree west longitude line crosses the antipode. The mid-Pacific recovery line crosses the antipode once each 24 hours, and if a time-critical situation forces an abort earlier than the selected fixed abort times, landings would be targeted for the Atlantic Ocean, West Pacific or Indian Ocean recovery lines in that order of preference. When the spacecraft enters the Moon's sphere of influence, a circumlunar abort becomes faster than an attempt to return directly to Earth.

Lunar Orbit Insertion phase --

Early SPS shutdowns during the lunar orbit insertion burn (LOI) are covered by three modes in the Apollo 11 mission. All three modes would result in the CM landing at the Earth latitude of the Moon antipode at the time the abort was performed.

Mode I would be a LM DPS posigrade burn into an Earth-return trajectory about two hours (at next pericyynthion) after an LOI shutdown during the first two minutes of the LOI burn.

Mode II, for SPS shutdown between two and three minutes after ignition, would use the LM DPS engine to adjust the orbit to a safe, non-lunar impact trajectory followed by a second DPS posigrade burn at next pericyynthion targeted for the mid-Pacific recovery line.

Mode III, from three minutes after LOI ignition until normal cutoff, would allow the spacecraft to coast through one or two lunar orbits before doing a DPS posigrade burn at pericyynthion targeted for the mid-Pacific recovery line.

Lunar Orbit Phase --

If during lunar parking orbit it became necessary to abort, the transearth injection (TEI) burn would be made early and would target spacecraft landing to the mid-Pacific recovery line.

Transearch Injection phase --

Early shutdown of the TEI burn between ignition and two minutes would cause a Mode III abort and a SPS posigrade TEI burn would be made at a later pericyynthion. Cutoffs after two minutes TEI burn time would call for a Mode I abort--restart of SPS as soon as possible for Earth-return trajectory. Both modes produce mid-Pacific recovery line landings near the latitude of the antipode at the time of the TEI burn.

Transearch Coast phase --

Adjustments of the landing point are possible during the transearch coast through burns with the SPS or the service module RCS thrusters, but in general, these are covered in the discussion of transearch midcourse corrections. No abort burns will be made later than 24 hours prior to entry to avoid effects upon CM entry velocity and flight path angle.

-more-

APOLLO 11 ONBOARD TELEVISION

Two television cameras will be carried aboard Apollo 11. A color camera of the type used on Apollo 10 will be stowed for use aboard the command module, and the black-and-white Apollo lunar television camera will be stowed in the LM descent stage for televising back to Earth a real-time record of man's first step onto the Moon.

The lunar television camera weighs 7.25 pounds and draws 6.5 watts of 24-32 volts DC power. Scan rate is 10 frames-per-second at 320 lines-per-frame. The camera body is 10.6 inches long, 6.5 inches wide and 3.4 inches deep. The bayonet lens mount permits lens changes by a crewman in a pressurized suit. Two lenses, a wideangle lens for close-ups and large areas, and a lunar day lens for viewing lunar surface features and activities in the near field of view with sunlight illumination, will be provided for the lunar TV camera.

The black-and-white lunar television camera is stowed in the MESA (Modular Equipment Stowage Assembly) in the LM descent stage and will be powered up before Armstrong starts down the LM ladder. When he pulls the lanyard to deploy the MESA, the TV camera will also swing down on the MESA to the left of the ladder (as viewed from LM front) and relay a TV picture of his initial steps on the Moon. Armstrong later will mount the TV camera on a tripod some distance away from the LM after Aldrin has descended to the surface. The camera will be left untended to cover the crew's activities during the remainder of the EVA.

The Apollo lunar television camera is built by Westinghouse Electric Corp., Aerospace Division, Baltimore, Md.

The color TV camera is a 12-pound Westinghouse camera with a zoom lens for wideangle or close-up use, and has a three-inch monitor which can be mounted on the camera or in the command module. The color camera outputs a standard 525-line, 30 frame-per-second signal in color by use of a rotating color wheel. The black-and-white signal from the spacecraft will be converted to color at the Mission Control Center.

The following is a preliminary plan for TV passes based upon a 9:32 a.m. EDT, July 16 launch.

TENTATIVE APOLLO 11 TV TIMES

<u>Date</u>	<u>Times of Planned TV (EDT)</u>	<u>GET</u>	<u>Prime Site</u>	<u>Event</u>
July 17	7:32 - 7:47 p.m.	34:00-34:15	Goldstone	Translunar Coast
July 18	7:32 - 7:47 p.m.	58:00-58:15	Goldstone	Translunar Coast
July 19	4:02 - 4:17 p.m.	78:30-78:45	Goldstone	Lunar Orbit (general sur- face shots)
July 20	1:52 - 2:22 p.m.	100:20-100:50	Madrid	CM/LM Formation Flying
July 21	1:57 - 2:07 a.m.	112:25-112:35	Goldstone	Landing Site Tracking
July 21	2:12 - 4:52 a.m.	112:40-115:20	*Parkes	Black and White Lunar Surface
July 22	9:02 - 9:17 p.m.	155:30-155:45	Goldstone	Transearth Coast
July 23	7:02 - 7:17 p.m.	177:30-177:45	Goldstone	Transearth Coast

* Honeysuckle will tape the Parkes pass and ship tape to MSC.

-more-

-78-

APOLLO 11 PHOTOGRAPHIC TASKS

Still and motion pictures will be made of most spacecraft maneuvers as well as of the lunar surface and of crew activities in the Apollo 11 cabin. During lunar surface activities after lunar module touchdown and the two hour 40 minute EVA, emphasis will be on photographic documentation of crew mobility, lunar surface features and lunar material sample collection.

Camera equipment carried on Apollo 11 consists of one 70mm Hasselblad electric camera stowed aboard the command module, two Hasselblad 70mm lunar surface superwide angle cameras stowed aboard the LM and a 35mm stereo close-up camera in the LM MESA.

The 2.3 pound Hasselblad superwide angle camera in the LM is fitted with a 38mm f/4.5 Zeiss Biogon lens with a focusing range from 12 inches to infinity. Shutter speeds range from time exposure and one second to 1/500 second. The angular field of view with the 38mm lens is 71 degrees vertical and horizontal on the square-format film frame.

The command module Hasselblad electric camera is normally fitted with an 80mm f/2.8 Zeiss Planar lens, but bayonet-mount 60mm and 250mm lens may be substituted for special tasks. The 80mm lens has a focusing range from three feet to infinity and has a field of view of 38 degrees vertical and horizontal.

Stowed with the Hasselblads are such associated items as a spotmeter, ringsight, polarizing filter, and film magazines. Both versions of the Hasselblad accept the same type film magazine.

For motion pictures, two Maurer 16mm data acquisition cameras (one in the CSM, one in the LM) with variable frame speed (1, 6, 12 and 24 frames per second) will be used. The cameras each weigh 2.8 pounds with a 130-foot film magazine attached. The command module 16mm camera will have lenses of 5, 18 and 75mm focal length available, while the LM camera will be fitted with the 18mm wideangle lens. Motion picture camera accessories include a right-angle mirror, a power cable and a command module boresight window bracket.

During the lunar surface extravehicular activity, the commander will be filmed by the LM pilot with the LM 16mm camera at normal or near-normal frame rates (24 and 12 fps), but when he leaves the LM to join the commander, he will switch to a one frame-per-second rate. The camera will be mounted inside the LM looking through the right-hand window. The 18mm lens has a horizontal field of view of 32 degrees and a vertical field of view of 23 degrees. At one fps, a 130-foot 16mm magazine will run out in 87 minutes in real time; projected at the standard 24 fps, the film would compress the 87 minutes to 3.6 minutes.

Armstrong and Aldrin will use the Hasselblad lunar surface camera extensively during their surface EVA to document each of their major tasks. Additionally, they will make a 360-degree overlapping panorama sequence of still photos of the lunar horizon, photograph surface features in the immediate area, make close-ups of geological samples and the area from which they were collected and record on film the appearance and condition of the lunar module after landing.

Stowed in the MESA is a 35mm stereo close-up camera which shoots 24mm square color stereo pairs with an image scale of one-half actual size. The camera is fixed focus and is equipped with a stand-off hood to position the camera at the proper focus distance. A long handle permits an EVA crewman to position the camera without stooping for surface object photography. Detail as small as 40 microns can be recorded.

A battery-powered electronic flash provides illumination. Film capacity is a minimum of 100 stereo pairs.

The stereo close-up camera will permit the Apollo 11 landing crew to photograph significant surface structure phenomena which would remain intact only in the lunar environment, such as fine powdery deposits, cracks or holes and adhesion of particles.

Near the end of EVA, the film cassette will be removed and stowed in the commander's contingency sample container pocket and the camera body will be left on the lunar surface.

LUNAR DESCRIPTION

Terrain - Mountainous and crater-pitted, the former rising thousands of feet and the latter ranging from a few inches to 180 miles in diameter. The craters are thought to be formed by the impact of meteorites. The surface is covered with a layer of fine-grained material resembling silt or sand, as well as small rocks and boulders.

Environment - No air, no wind, and no moisture. The temperature ranges from 243 degrees in the two-week lunar day to 279 degrees below zero in the two-week lunar night. Gravity is one-sixth that of Earth. Micrometeoroids pelt the Moon (there is no atmosphere to burn them up). Radiation might present a problem during periods of unusual solar activity.

Dark Side - The dark or hidden side of the Moon no longer is a complete mystery. It was first photographed by a Russian craft and since then has been photographed many times, particularly by NASA's Lunar Orbiter spacecraft and Apollo 8.

Origin - There is still no agreement among scientists on the origin of the Moon. The three theories: (1) the Moon once was part of Earth and split off into its own orbit, (2) it evolved as a separate body at the same time as Earth, and (3) it formed elsewhere in space and wandered until it was captured by Earth's gravitational field.

Physical Facts

Diameter	2,160 miles (about $\frac{1}{4}$ that of Earth)
Circumference	6,790 miles (about $\frac{1}{4}$ that of Earth)
Distance from Earth	238,857 miles (mean; 221,463 minimum to 252,710 maximum)
Surface temperature	+243°F (Sun at zenith) -279°F (night)
Surface gravity	1/6 that of Earth
Mass	1/100th that of Earth
Volume	1/50th that of Earth
Lunar day and night	14 Earth days each
Mean velocity in orbit	2,287 miles per hour
Escape velocity	1.48 miles per second
Month (period of rotation around Earth)	27 days, 7 hours, 43 minutes

Apollo Lunar Landing Sites

Possible landing sites for the Apollo lunar module have been under study by NASA's Apollo Site Selection Board for more than two years. Thirty sites originally were considered. These have been narrowed down to three for the first lunar landing. (Site 1 currently not considered for first landing.)

Selection of the final sites was based on high resolution photographs by Lunar Orbiter spacecraft, plus close-up photos and surface data provided by the Surveyor spacecraft which soft-landed on the Moon.

The original sites are located on the visible side of the Moon within 45 degrees east and west of the Moon's center and 5 degrees north and south of its equator.

The final site choices were based on these factors:

- *Smoothness (relatively few craters and boulders)
- *Approach (no large hills, high cliffs, or deep craters that could cause incorrect altitude signals to the lunar module landing radar)
- *Propellant requirements (selected sites require the least expenditure of spacecraft propellants)
- *Recycle (selected sites allow effective launch preparation recycling if the Apollo Saturn V countdown is delayed)
- *Free return (sites are within reach of the spacecraft launched on a free return translunar trajectory)
- *Slope (there is little slope -- less than 2 degrees in the approach path and landing area)

24°E

25°

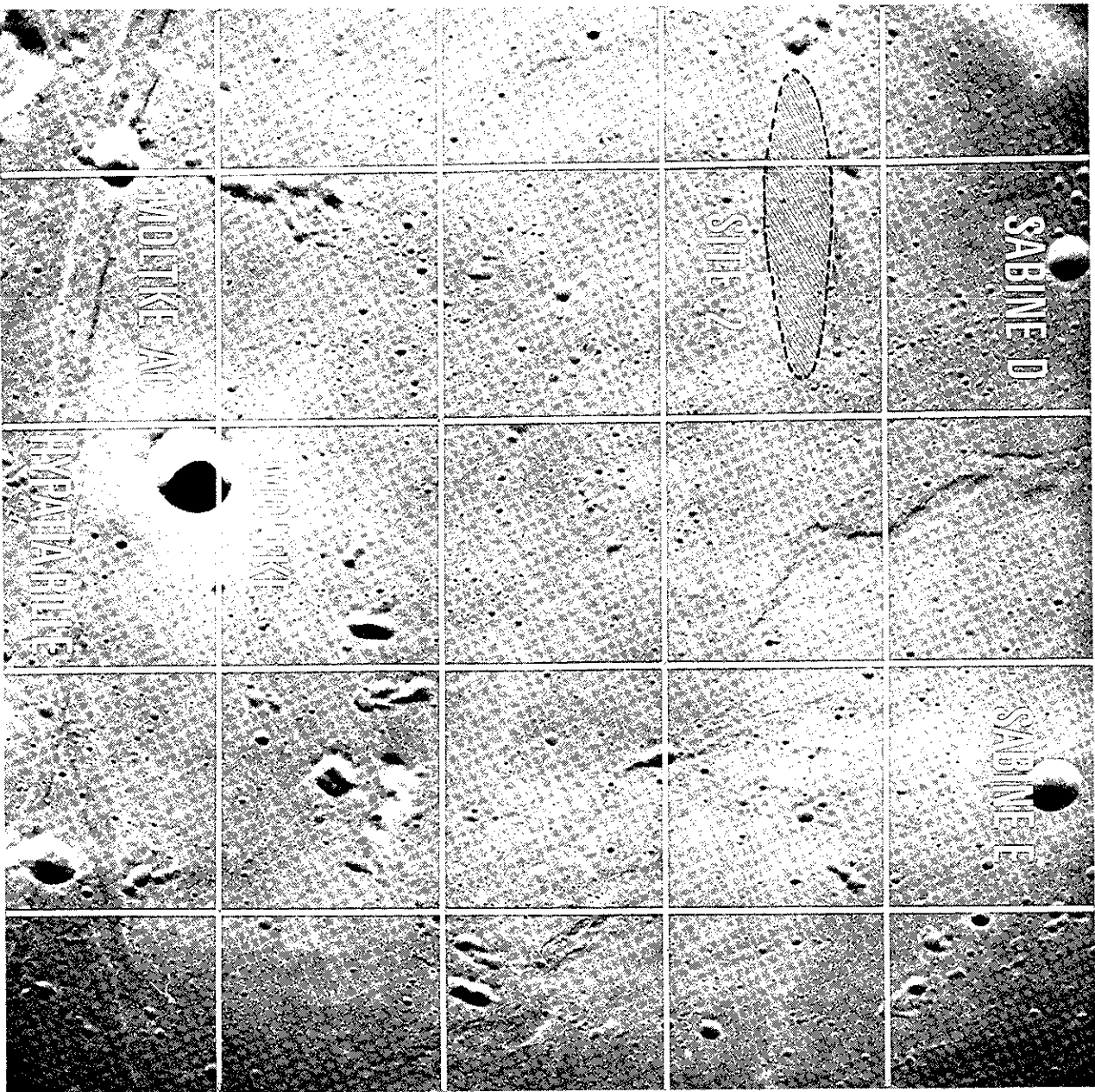

-more-

The Apollo 11 Landing Sites Are:

Site 2

latitude $0^{\circ} 42' 50''$ North
longitude $23^{\circ} 42' 28''$ East

Site 2 is located on the east central part of the Moon in southwestern Mar Tranquillitatis. The site is approximately 62 miles (100 kilometers) east of the rim of Crater Sabine and approximately 118 miles (190 kilometers) southwest of the Crater Maskelyne.

Site 3

latitude $0^{\circ} 21' 10''$ North
longitude $1^{\circ} 17' 57''$ West

Site 3 is located near the center of the visible face of the Moon in the southwestern part of Sinus Medii. The site is approximately 25 miles (40 kilometers) west of the center of the face and 21 miles (50 kilometers) southwest of the Crater Bruce.

Site 5

latitude $1^{\circ} 40' 41''$ North
longitude $41^{\circ} 53' 57''$ West

Site 5 is located on the west central part of the visible face in southeastern Oceanus Procellarum. The site is approximately 130 miles (210 kilometers) southwest of the rim of Crater Kepler and 118 miles (190 kilometers) north northeast of the rim of Crater Flamsteed.

-more-

COMMAND AND SERVICE MODULE STRUCTURE, SYSTEMS

The Apollo spacecraft for the Apollo 11 mission is comprised of Command Module 107, Service Module 107, Lunar Module 5, a spacecraft-lunar module adapter (SLA) and a launch escape system. The SLA serves as a mating structure between the instrument unit atop the S-IVB stage of the Saturn V launch vehicle and as a housing for the lunar module.

Launch Escape System (LES) -- Propels command module to safety in an aborted launch. It is made up of an open-frame tower structure, mounted to the command module by four frangible bolts, and three solid-propellant rocket motors: a 147,000 pound-thrust launch escape system motor, a 2,400-pound-thrust pitch control motor, and a 31,500-pound-thrust tower jettison motor. Two canard vanes near the top deploy to turn the command module aerodynamically to an attitude with the heat-shield forward. Attached to the base of the launch escape tower is a boost protective cover composed of resin impregnated fiberglass covered with cork, that protects the command module from aerodynamic heating during boost and rocket exhaust gases from the main and the jettison motors. The system is 33 feet tall, four feet in diameter at the base, and weighs 8,910 pounds.

Command Module (CM) Structure -- The basic structure of the command module is a pressure vessel encased in heat shields, cone-shaped 11 feet 5 inches high, base diameter of 12 feet 10 inches, and launch weight 12,250 pounds.

The command module consists of the forward compartment which contains two reaction control engines and components of the Earth landing system; the crew compartment or inner pressure vessel containing crew accommodations, controls and displays, and many of the spacecraft systems; and the aft compartment housing ten reaction control engines, propellant tankage, helium tanks, water tanks, and the CSM umbilical cable. The crew compartment contains 210 cubic feet of habitable volume.

Heat-shields around the three compartments are made of brazed stainless steel honeycomb with an outer layer of phenolic epoxy resin as an ablative material. Shield thickness, varying according to heat loads, ranges from 0.7 inch at the apex to 2.7 inches at the aft end.

The spacecraft inner structure is of sheet-aluminum honeycomb bonded sandwich ranging in thickness from 0.25 inch thick at forward access tunnel to 1.5 inches thick at base.

APOLLO SPACECRAFT

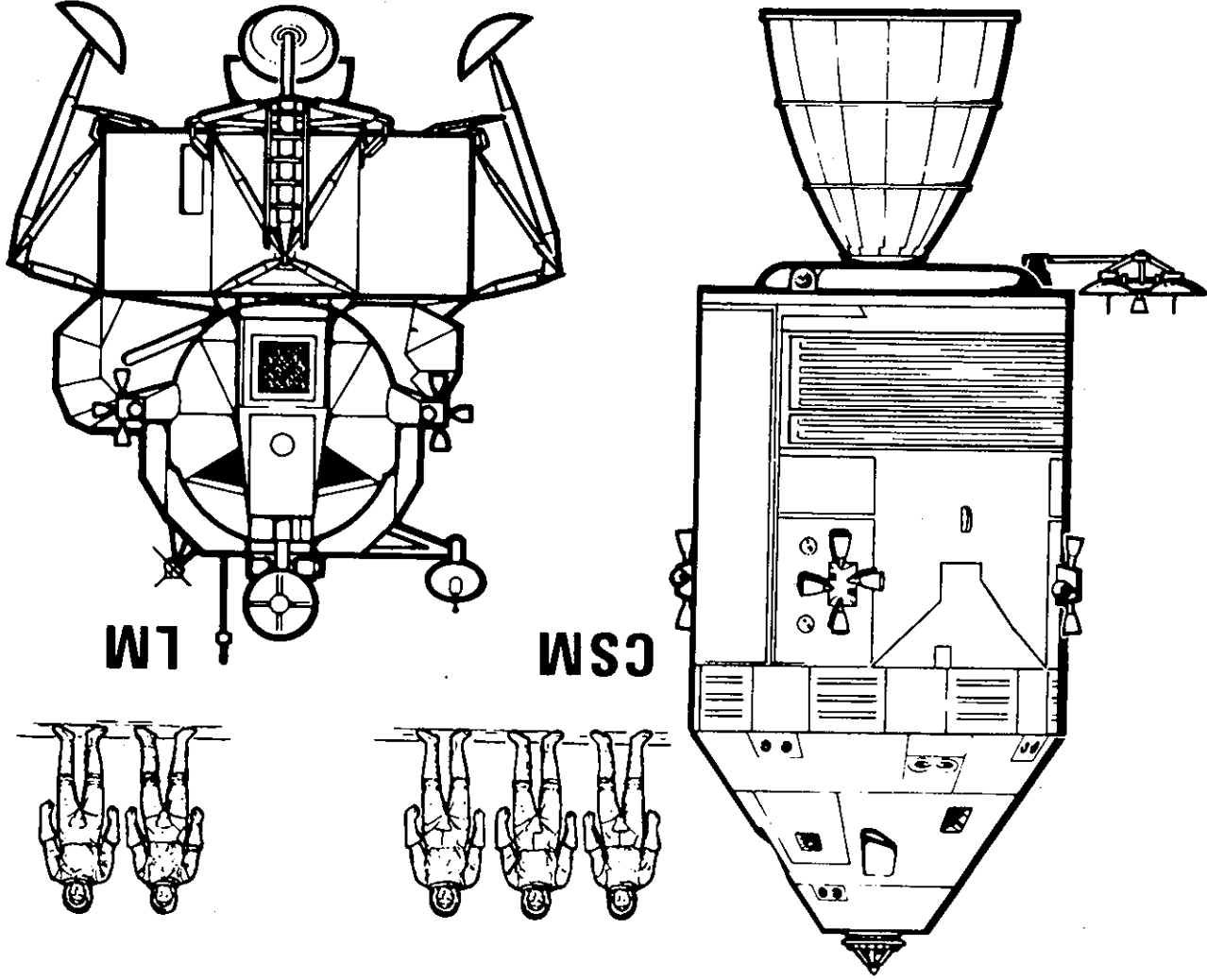

CSM 107 and LM-5 are equipped with the probe-and-drogue docking hardware. The probe assembly is a powered folding coupling and impact attenuating device mounted on the CM tunnel that mates with a conical drogue mounted in the LM docking tunnel. After the 12 automatic docking latches are checked following a docking maneuver, both the probe and drogue assemblies are removed from the vehicle tunnels and stowed to allow free crew transfer between the CSM and LM.

Service Module (SM) Structure -- The service module is a cylinder 12 feet 10 inches in diameter by 24 feet 7 inches high. For the Apollo 11 mission, it will weigh, 51,243 pounds at launch. Aluminum honeycomb panels one inch thick form the outer skin, and milled aluminum radial beams separate the interior into six sections around a central cylinder containing two helium spheres, four sections containing service propulsion system fuel-oxidizer tankage, another containing fuel cells, cryogenic oxygen and hydrogen, and one sector essentially empty.

Spacecraft-LM Adapter (SLA) Structure -- The spacecraft LM adapter is a truncated cone 28 feet long tapering from 260 inches diameter at the base to 154 inches at the forward end at the service module mating line. Aluminum honeycomb 1.75 inches thick is the stressed-skin structure for the spacecraft adapter. The SLA weighs 4,000 pounds.

CSM Systems

Guidance, Navigation and Control System (GNCS) -- Measures and controls spacecraft position, attitude, and velocity, calculates trajectory, controls spacecraft propulsion system thrust vector, and displays abort data. The guidance system consists of three subsystems: inertial, made up of an inertial measurement unit and associated power and data components; computer which processes information to or from other components; and optics, including scanning telescope and sextant for celestial and/or landmark spacecraft navigation. CSM 107 and subsequent modules are equipped with a VHF ranging device as a backup to the LM rendezvous radar.

Stabilization and Control Systems (SCS) -- Controls spacecraft rotation, translation, and thrust vector and provides displays for crew-initiated maneuvers; backs up the guidance system. It has three subsystems; attitude reference, attitude control, and thrust vector control.

Service Propulsion System (SPS) -- Provides thrust for large spacecraft velocity changes through a gimbal-mounted 20,500-pound-thrust hypergolic engine using a nitrogen tetroxide oxidizer and a 50-50 mixture of unsymmetrical dimethyl hydrazine and hydrazine fuel. This system is in the service module. The system responds to automatic firing commands from the guidance and navigation system or to manual commands from the crew. The engine provides a constant thrust level. The stabilization and control system gimbals the engine to direct the thrust vector through the spacecraft center of gravity.

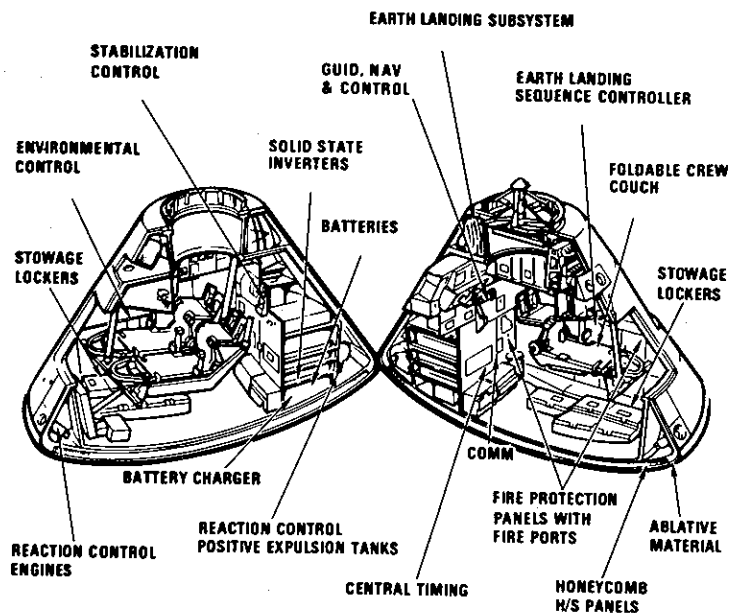
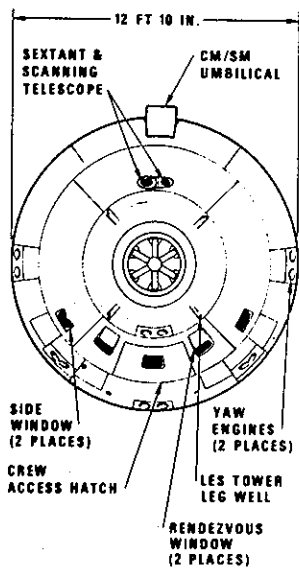
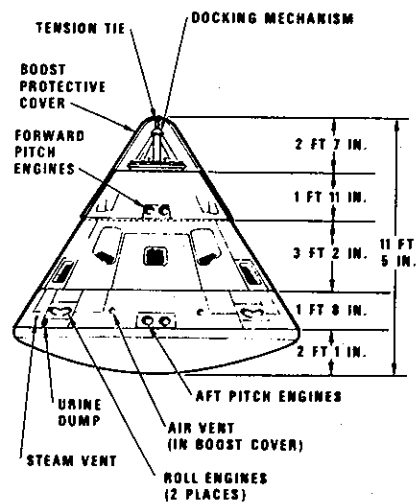

COMMAND MODULE

SERVICE MODULE

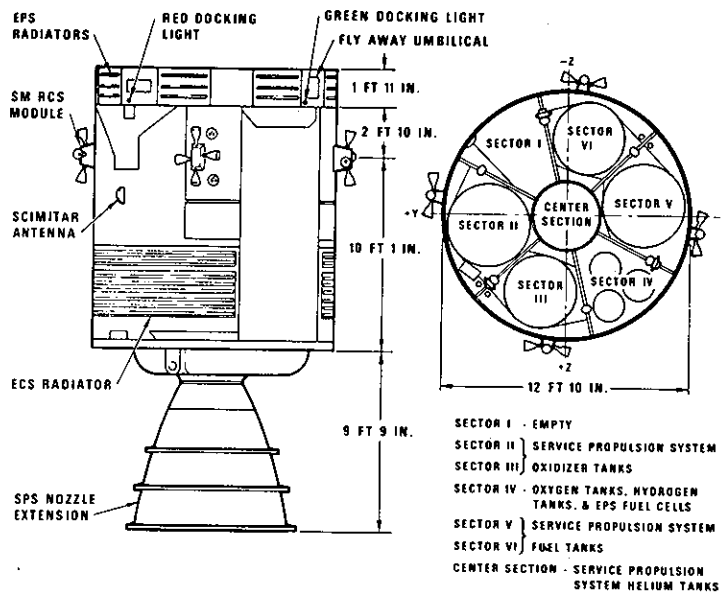

Telecommunications System -- Provides voice, television, telemetry, and command data and tracking and ranging between the spacecraft and Earth, between the command module and the lunar module and between the spacecraft and the extravehicular astronaut. It also provides intercommunications between astronauts. The telecommunications system consists of pulse code modulated telemetry for relaying to Manned Space Flight Network stations data on spacecraft systems and crew condition, VHF/AM voice, and unified S-Band tracking transponder, air-to-ground voice communications, onboard television, and a VHF recovery beacon. Network stations can transmit to the spacecraft such items as updates to the Apollo guidance computer and central timing equipment, and real-time commands for certain onboard functions.

The high-gain steerable S-Band antenna consists of four, 31-inch-diameter parabolic dishes mounted on a folding boom at the aft end of the service module. Nested alongside the service propulsion system engine nozzle until deployment, the antenna swings out at right angles to the spacecraft longitudinal axis, with the boom pointing 52 degrees below the heads-up horizontal. Signals from the ground stations can be tracked either automatically or manually with the antenna's gimbaling system. Normal S-Band voice and uplink/downlink communications will be handled by the omni and high-gain antennas.

Sequential System -- Interfaces with other spacecraft systems and subsystems to initiate time critical functions during launch, docking maneuvers, sub-orbital aborts, and entry portions of a mission. The system also controls routine spacecraft sequencing such as service module separation and deployment of the Earth landing system.

Emergency Detection System (EDS) -- Detects and displays to the crew launch vehicle emergency conditions, such as excessive pitch or roll rates or two engines out, and automatically or manually shuts down the booster and activates the launch escape system; functions until the spacecraft is in orbit.

Earth Landing System (ELS) -- Includes the drogue and main parachute system as well as post-landing recovery aids. In a normal entry descent, the command module forward heat shield is jettisoned at 24,000 feet, permitting mortar deployment of two reefed 16.5-foot diameter drogue parachutes for orienting and decelerating the spacecraft. After disreef and drogue release, three mortar deployed pilot chutes pull out the three main 83.3-foot diameter parachutes with two-stage reefing to provide gradual inflation in three steps. Two main parachutes out of three can provide a safe landing.

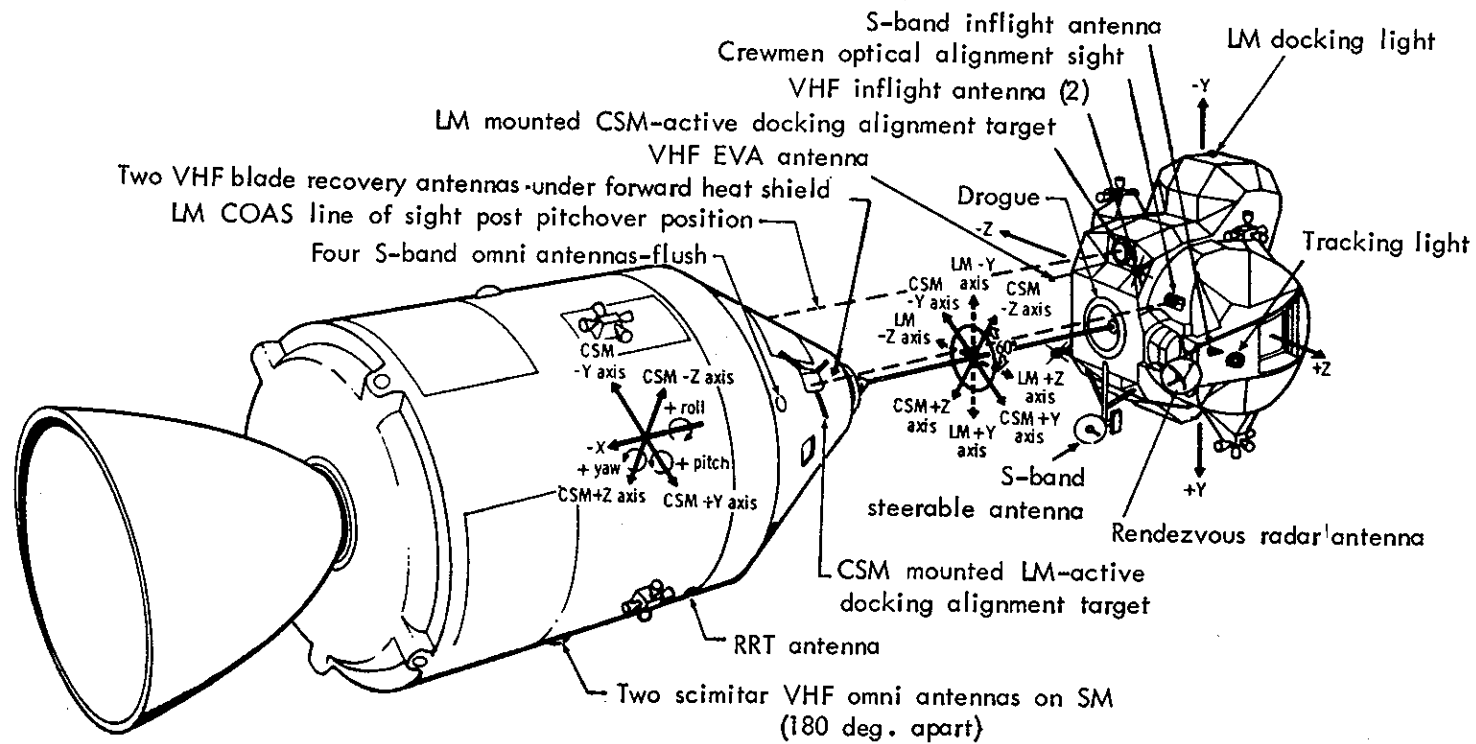

-MORE-

-91-

SPACECRAFT AXIS AND ANTENNA LOCATIONS

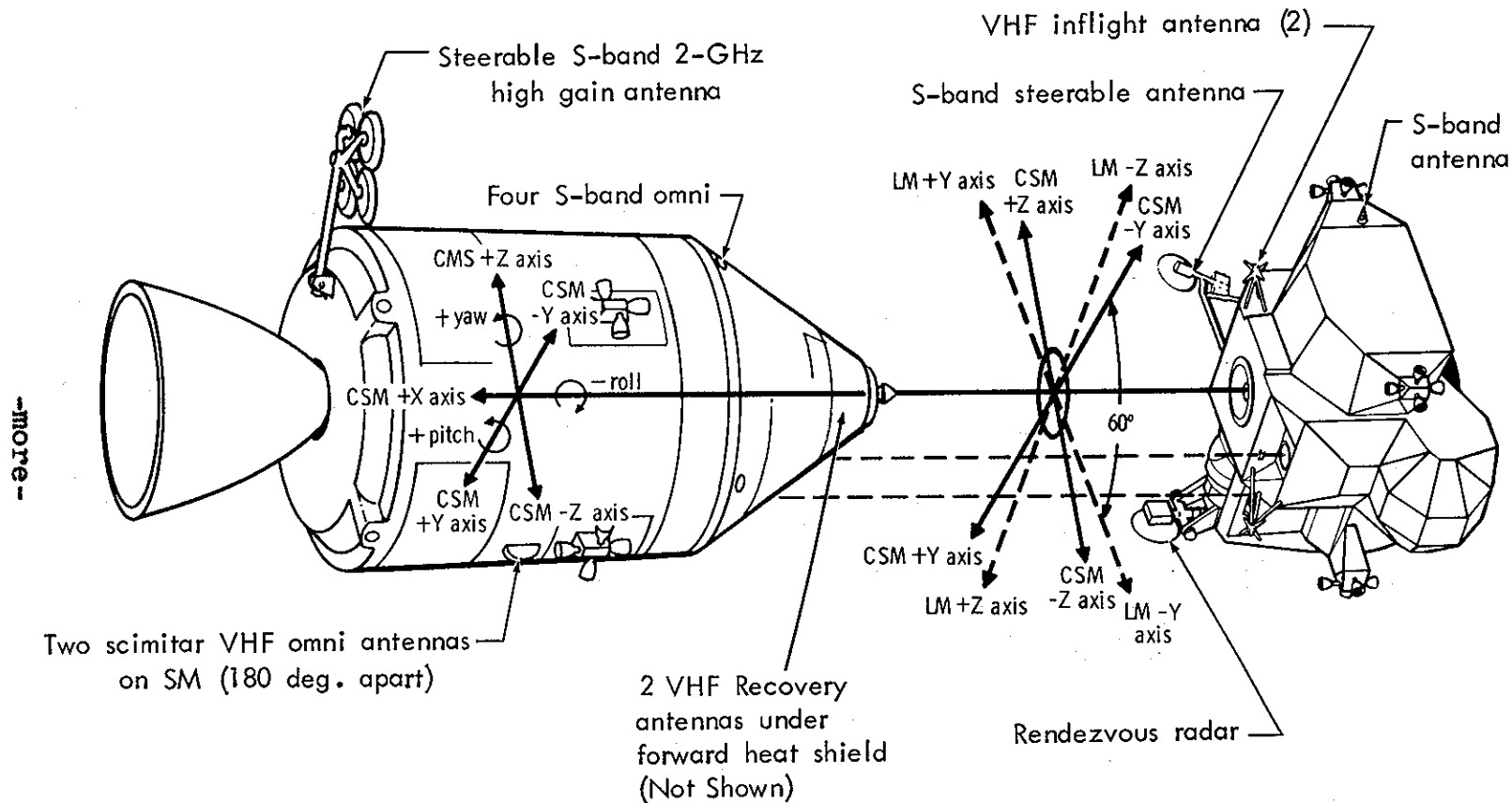

-more-

-92-

SPACECRAFT AXIS AND ANTENNA LOCATIONS

Reaction Control System (RCS) -- The command module and the service module each has its own independent system. The SM RCS has four identical RCS "quads" mounted around the SM 90 degrees apart. Each quad has four 100 pound-thrust engines, two fuel and two oxidizer tanks and a helium pressurization sphere. The SM RCS provides redundant spacecraft attitude control through cross-coupling logic inputs from the stabilization and guidance systems. Small velocity change maneuvers can also be made with the SM RCS.

The CM RCS consists of two independent six-engine subsystems of six 93 pound-thrust engines each. Both subsystems are activated just prior to CM separation from the SM: one is used for spacecraft attitude control during entry. The other serves in standby as a backup. Propellants for both CM and SM RCS are monomethyl hydrazine fuel and nitrogen tetroxide oxidizer with helium pressurization. These propellants are hypergolic, i.e., they burn spontaneously when combined without an igniter.

Electrical Power System (EPS) -- Provides electrical energy sources, power generation and control, power conversion and conditioning, and power distribution to the spacecraft throughout the mission. The EPS also furnishes drinking water to the astronauts as a by-product of the fuel cells. The primary source of electrical power is the fuel cells mounted in the SM. Each cell consists of a hydrogen compartment, an oxygen compartment, and two electrodes. The cryogenic gas storage system, also located in the SM, supplies the hydrogen and oxygen used in the fuel cell power plants, as well as the oxygen used in the ECS.

Three silver-zinc oxide storage batteries supply power to the CM during entry and after landing, provide power for sequence controllers, and supplement the fuel cells during periods of peak power demand. These batteries are located in the CM lower equipment bay. A battery charger is located in the same bay to assure a full charge prior to entry.

Two other silver-zinc oxide batteries, independent of and completely isolated from the rest of the dc power system, are used to supply power for explosive devices for CM/SM separation, parachute deployment and separation, third-stage separation, launch escape system tower separation, and other pyrotechnic uses.

Environmental Control System (ECS) -- Controls spacecraft atmosphere, pressure, and temperature and manages water. In addition to regulating cabin and suit gas pressure, temperature and humidity, the system removes carbon dioxide, odors and particles, and ventilates the cabin after landing. It collects and stores fuel cell potable water for crew use, supplies water to the glycol evaporators for cooling, and dumps surplus water overboard through the urine dump valve. Proper operating temperature of electronics and electrical equipment is maintained by this system through the use of the cabin heat exchangers, the space radiators, and the glycol evaporators.

Recovery aids include the uprighting system, swimmer inter-phone connections, sea dye marker, flashing beacon, VHF recovery beacon, and VHF transceiver. The uprighting system consists of three compressor-inflated bags to upright the spacecraft if it should land in the water apex down (stable II position).

Caution and Warning System -- Monitors spacecraft systems for out-of-tolerance conditions and alerts crew by visual and audible alarms so that crewmen may trouble-shoot the problem.

Controls and Displays -- Provide readouts and control functions of all other spacecraft systems in the command and service modules. All controls are designed to be operated by crewmen in pressurized suits. Displays are grouped by system and located according to the frequency the crew refers to them.

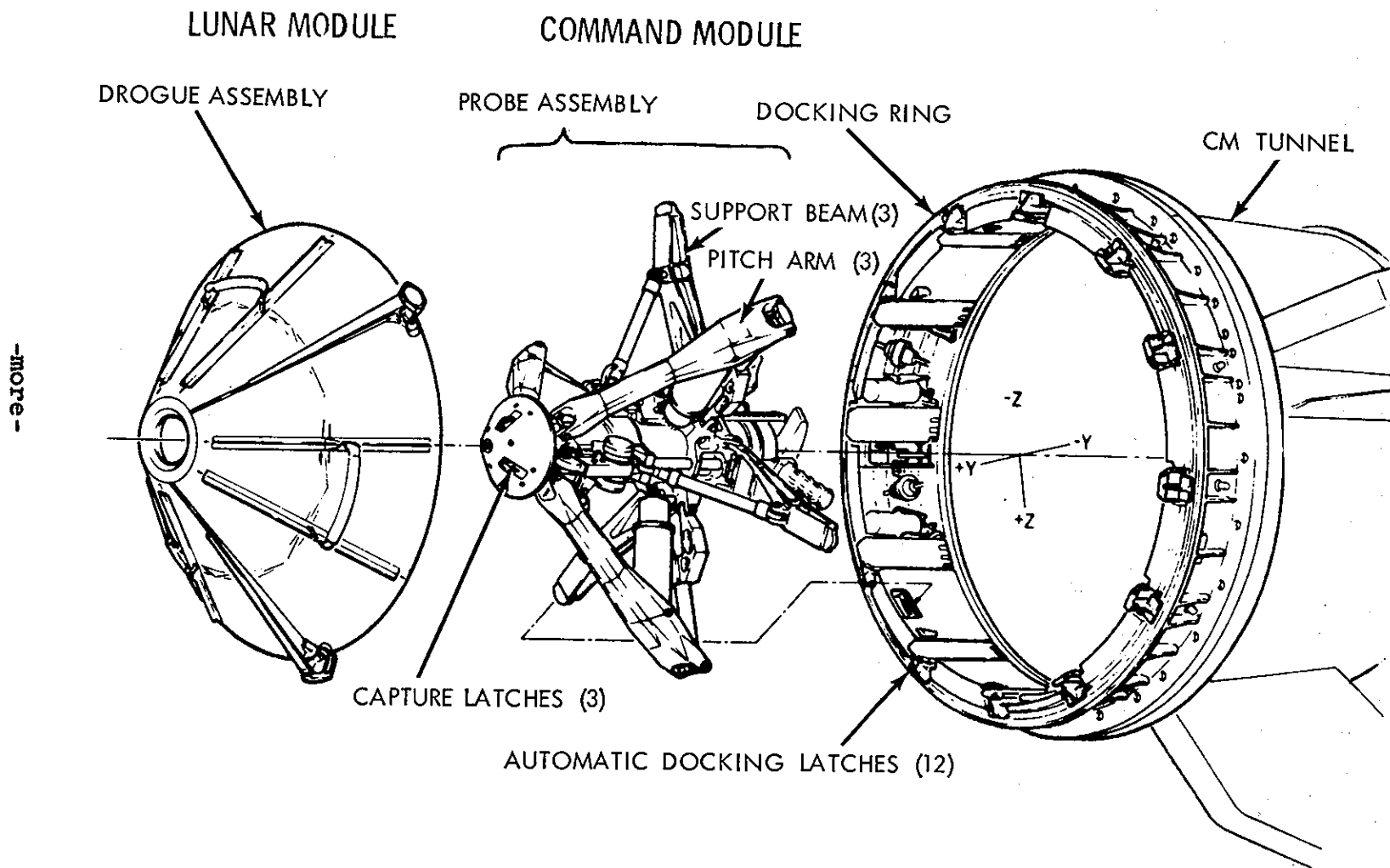

APOLLO DOCKING MECHANISMS

LUNAR MODULE STRUCTURES, WEIGHT

The lunar module is a two-stage vehicle designed for space operations near and on the Moon. The LM is incapable of reentering the atmosphere. The lunar module stands 22 feet 11 inches high and is 31 feet wide (diagonally across landing gear).

Joined by four explosive bolts and umbilicals, the ascent and descent stages of the LM operate as a unit until staging, when the ascent stage functions as a single spacecraft for rendezvous and docking with the CSM.

Ascent Stage

Three main sections make up the ascent stage: the crew compartment, midsection, and aft equipment bay. Only the crew compartment and midsection are pressurized (4.8 psig; 337.4 gm/sq cm) as part of the LM cabin; all other sections of the LM are unpressurized. The cabin volume is 235 cubic feet (6.7 cubic meters). The ascent stage measures 12 feet 4 inches high by 14 feet 1 inch in diameter.

Structurally, the ascent stage has six substructural areas: crew compartment, midsection, aft equipment bay, thrust chamber assembly cluster supports, antenna supports and thermal and micrometeoroid shield.

The cylindrical crew compartment is a semimonocoque structure of machined longerons and fusion-welded aluminum sheet and is 92 inches (2.35 m) in diameter and 42 inches (1.07 m) deep. Two flight stations are equipped with control and display panels, armrests, body restraints, landing aids, two front windows, an overhead docking window, and an alignment optical telescope in the center between the two flight stations. The habitable volume is 160 cubic feet.

Two triangular front windows and the 32-inch (0.81 m) square inward-opening forward hatch are in the crew compartment front face.

External structural beams support the crew compartment and serve to support the lower interstage mounts at their lower ends. Ring-stiffened semimonocoque construction is employed in the midsection, with chem-milled aluminum skin over fusion-welded longerons and stiffeners. Fore-and-aft beams across the top of the midsection join with those running across the top of the cabin to take all ascent stage stress loads and, in effect, isolate the cabin from stresses.

-more-

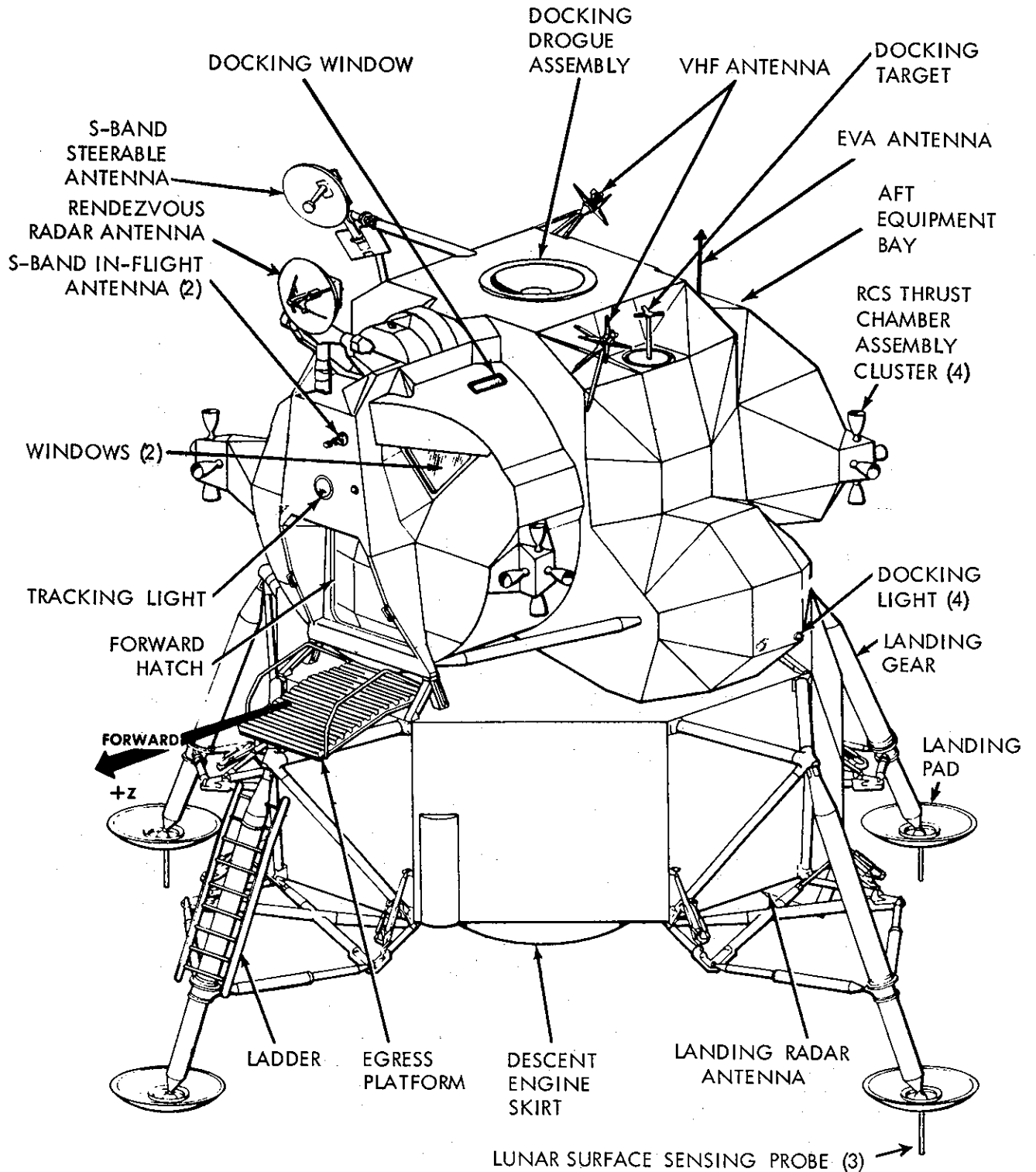

APOLLO LUNAR MODULE

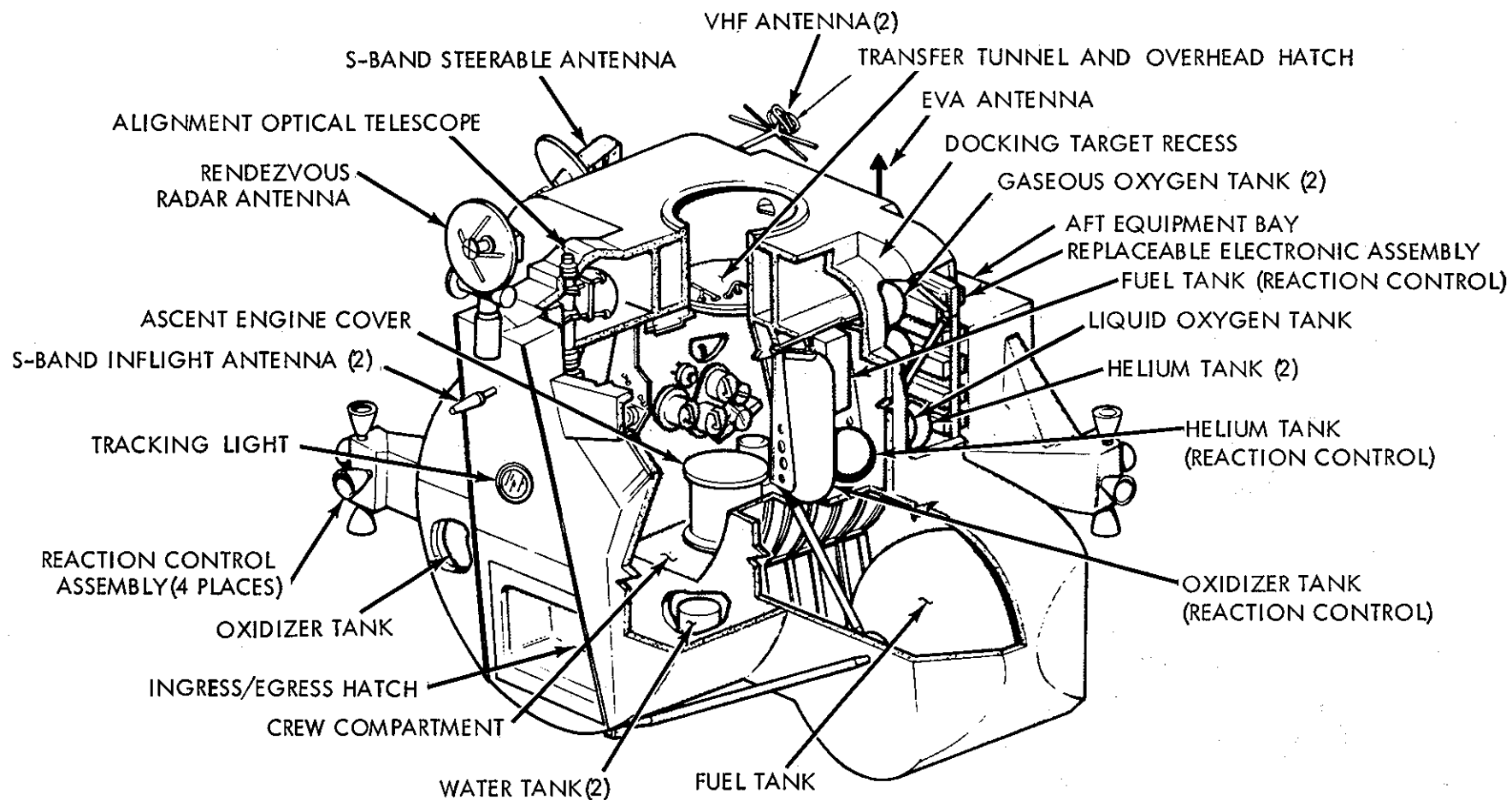

APOLLO LUNAR MODULE - ASCENT STAGE

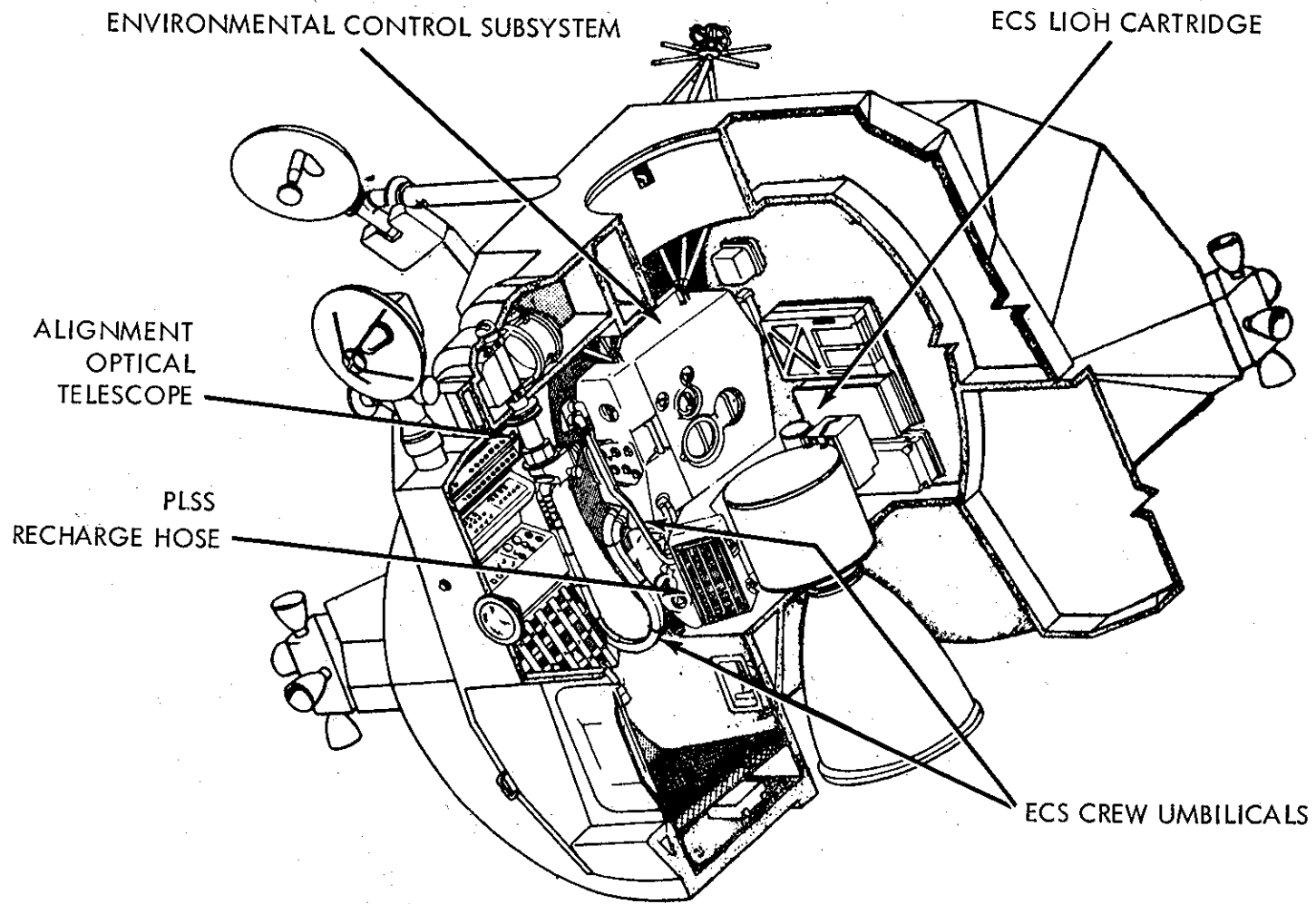

-more-

-99-

LM CABIN INTERIOR, LEFT HALF

-more-

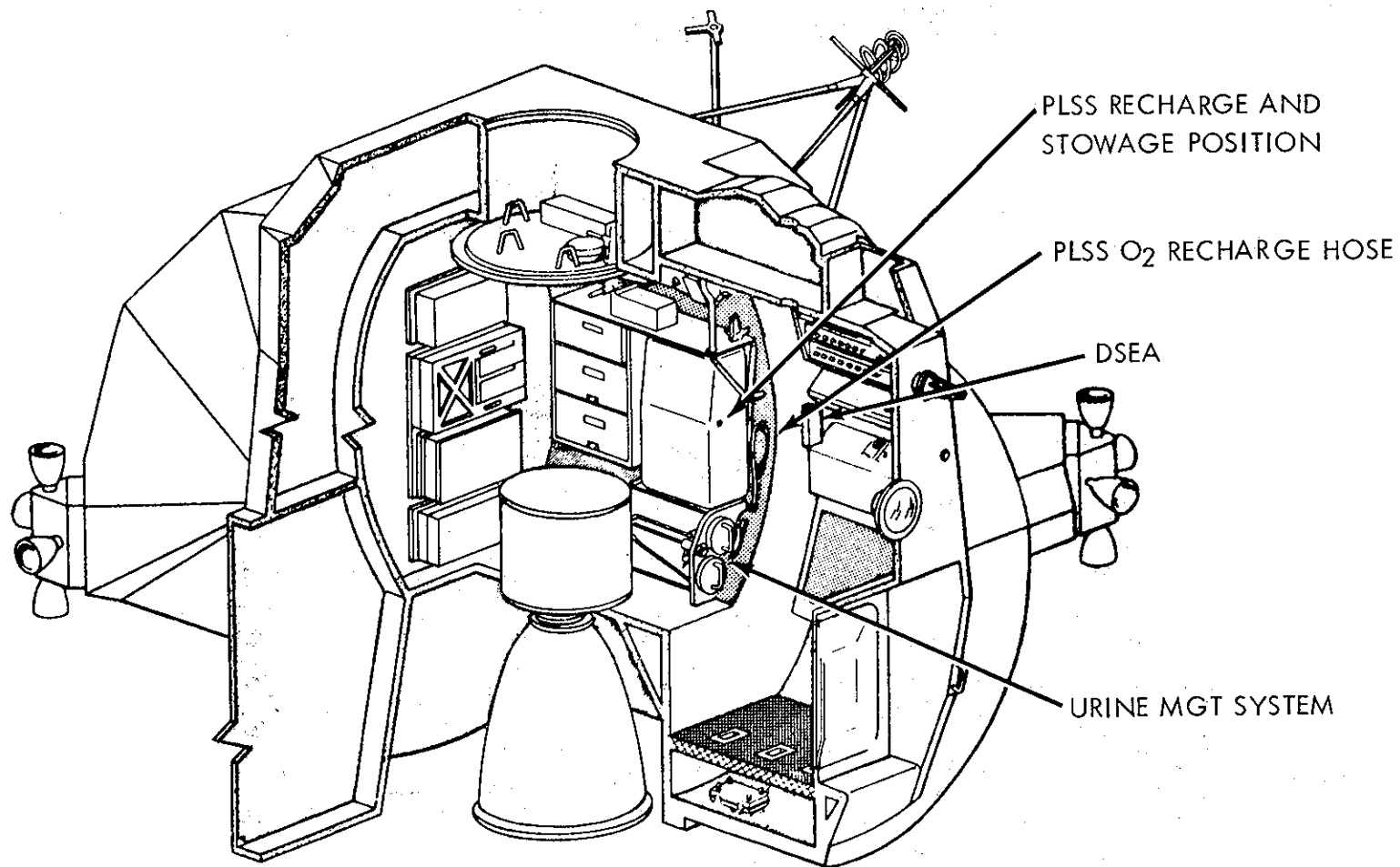

-100-

LM CABIN INTERIOR, RIGHT HALF